

Just Transition Toolbox

for coal regions

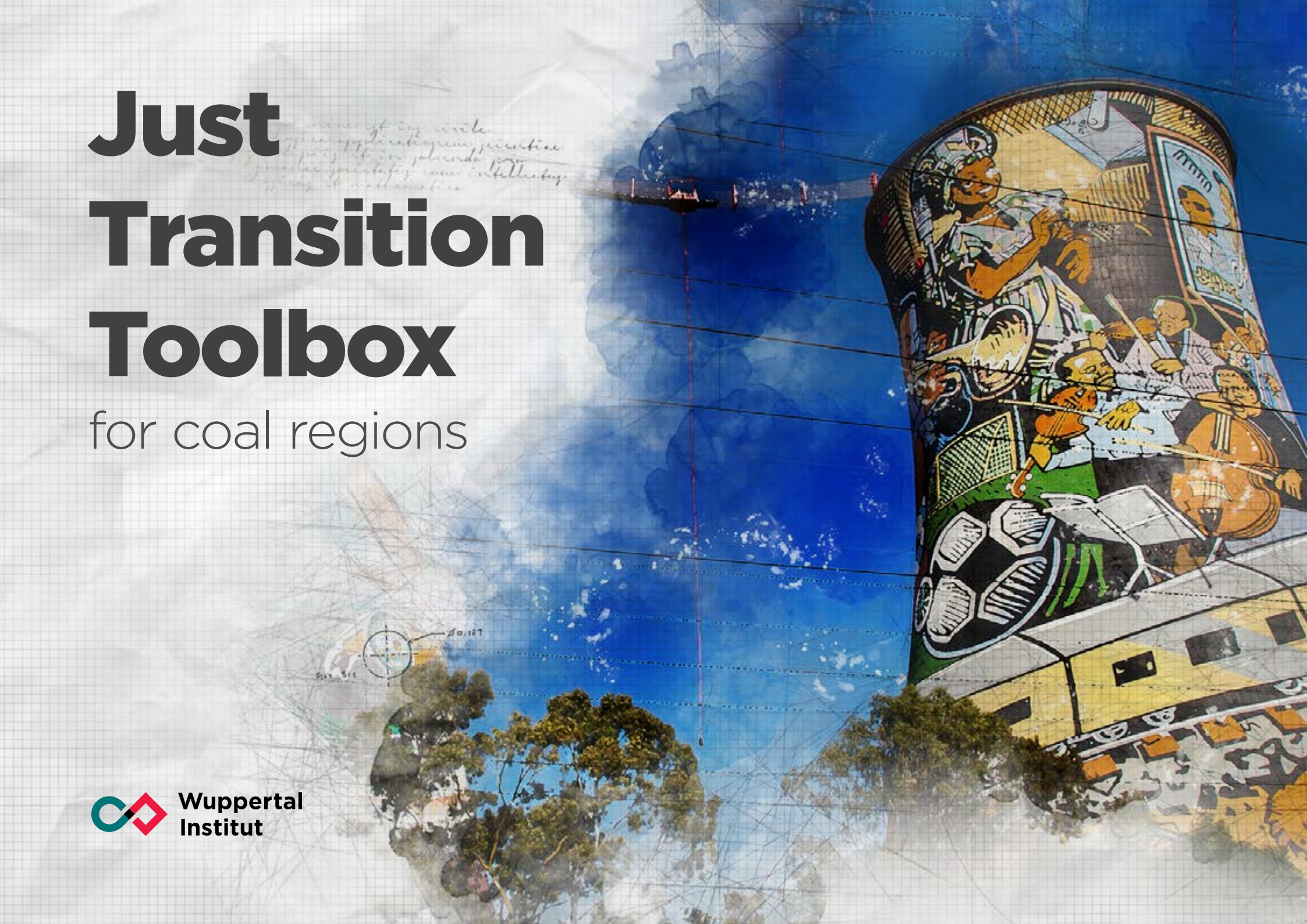

Wuppertal
Institut



The development of this toolbox has been supported by the *Strategic Partnerships for the Implementation of the Paris Agreement (SPIPA)* project, managed by the Deutsche Gesellschaft für Internationale Zusammenarbeit (GIZ) and co-funded by the European Union and the German Ministry for the Environment, Nature Conservation, Nuclear Safety and Consumer Protection (BMU).

The content of this publication is the responsibility of the authors.

Authors

Jannis Beutel, Wuppertal Institute
 Jenny Kurwan, Wuppertal Institute
 Annisa Wallenta, Wuppertal Institute
 Timon Wehnert, Wuppertal Institute
 María Yetano Roche, Wuppertal Institute

Please cite the report as follows

*Wuppertal Institute (2022). Just Transition
 Toolbox for coal regions*

Acknowledgement

This toolbox builds on the vast knowledge and previous work of the Secretariat of the Initiative for coal regions in transition (CRIT). We would like to thank all the experts and regional practitioners involved in this process for their contributions, and especially the following people and organisations:

Christiane Beuermann, Wuppertal Institute
 Andrzej Błachowicz, Climate Strategies
 Andrea Broughton, Ecorys
 Peta Wolpe, independent consultant
 Dr. Srestha Banerjee, India Just Transition Centre

Publisher

Wuppertal Institut für Klima, Umwelt, Energie gGmbH
 Döppersberg 19, 42103 Wuppertal, Germany

www.wupperinst.org

Contact

Timon Wehnert, Division Future
 Energy and Industry Systems

Wuppertal Institute - Berlin Office
 Neue Promenade 6
 10178 Berlin, Germany

timon.wehnert@wupperinst.org

Date

7th of March 2022

The text of this publication is licensed under Creative Commons Attributions 4.0 International license (CC BY 4.0).

The license is available at: <https://creativecommons.org/licenses/by/4.0/>

Supported by



This publication was produced with the financial support of the European Union's Partnership Instrument and the German Federal Ministry for the Environment, Nature Conservation, Nuclear Safety and Consumer Protection (BMU) in the context of the International Climate Initiative (IKI). The contents of this publication are the sole responsibility of Wuppertal Institut für Klima, Umwelt, Energie gGmbH and do not necessarily reflect the views of the funders.

Preface

This Just Transition Toolbox is largely based on a set of [toolkits](#) that the Wuppertal Institute has developed in collaboration with a broad range of stakeholders for the [EU Initiative for Coal Regions in Transition](#). It thus showcases learnings from coal regions in Europe to a large extent. For this toolbox, the aim was to scale up the extensive knowledge gained from the Initiative's work to a global perspective, including experiences and knowledge from countries outside the EU.

This toolbox is therefore intended to provide an initial overview of the most important practical learnings and concepts that we found to be beneficial for practitioners across the globe. However, there will most likely be some Eurocentric biases – so if you have any suggestions on how to improve this toolbox, do not hesitate to contact us. We look forward to your feedback, criticism and suggestions.

In keep with our belief that ongoing mutual learning across regions, countries and cultures will be one of the key drivers for successful transitions, we would also like to invite all readers to share their experiences, good practices and implementation knowledge with others. But for now, we hope that this Just Transition Toolbox can support your work, inspire you and help you, your colleagues and partners to try something new in this challenging process that lies ahead of us.

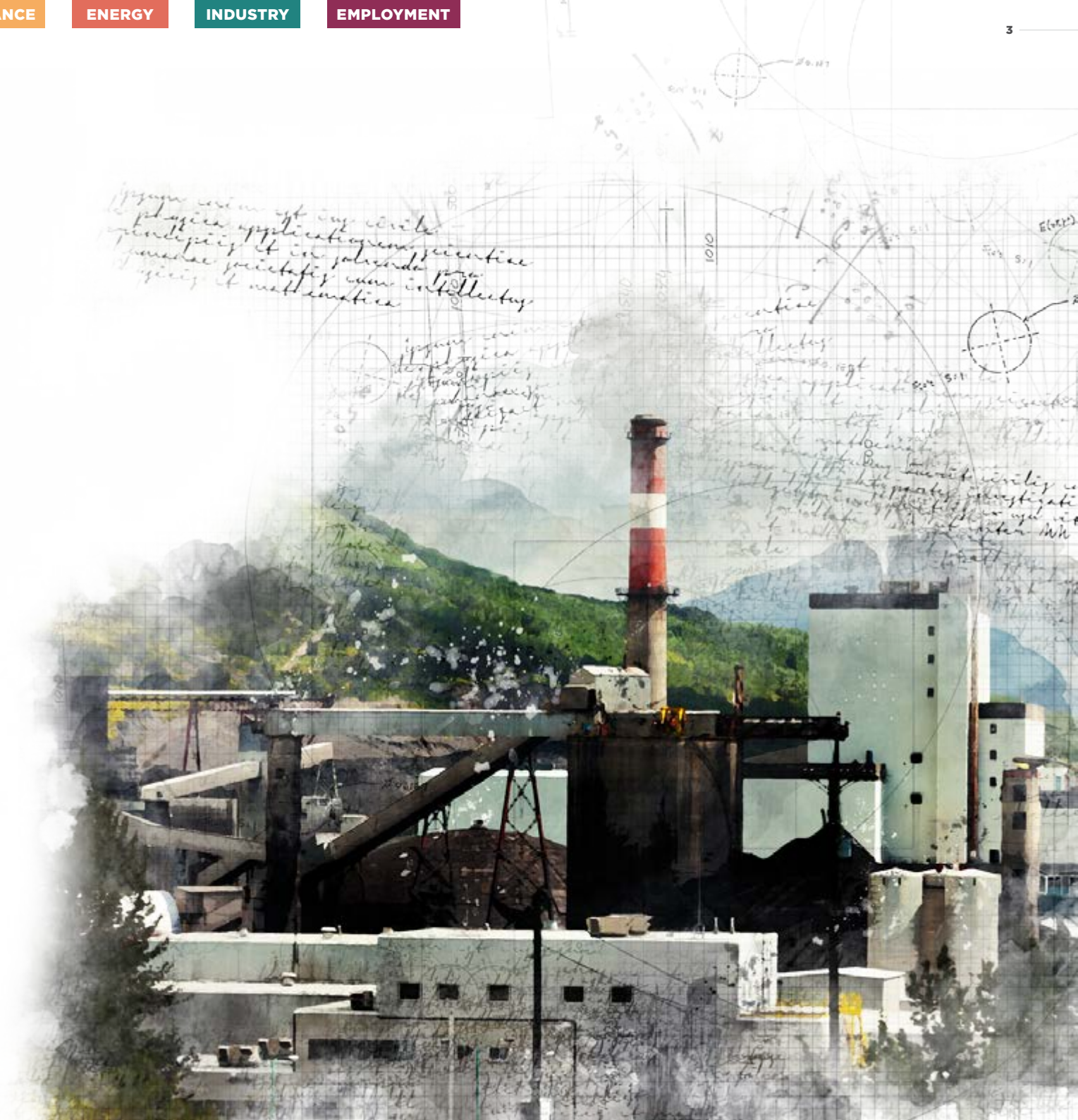



Use this menu to navigate through the document

Table of contents

Introduction	5		
About Just (Energy) Transitions	11		
Further resources	16		
1. Developing strategies for a Just Transition in coal regions	17		
Key messages & Overview	18		
Why do we need transition strategies?	20		
The policy cycle	22		
The problem	23		
The target	27		
The action	29		
The learning	35		
Further resources	38		
		2. Designing effective governance models	40
		Key messages & Overview	41
		Introduction	43
		Designing the governance model	44
		Cooperation levels and actors	48
		Stakeholder engagement and partnership building	51
		Social dialogue	61
		Further resources	64
		3. Making the shift from fossil to renewable energy	65
		Key messages & Overview	66
		Introduction	68
		Renewable energy technologies	69
		Energy technologies with uncertain prospects	79
		Coal-related infrastructure repurposing	86
		Further resources	95
		4. Decarbonising energy-intensive industries	96
		Key messages & Overview	97
		The role of energy-intensive industries for the transition	99
		Technology options to decarbonise steel production	101
		Hydrogen	108
		Further resources	114
		5. Paving the way for new business opportunities and sustainable employment	115
		Key messages & Overview	116
		Introduction	118
		Skills	121
		Support for workers	125
		Economic diversification and transformation	129
		Further resources	136

INTRODUCTION

Just Transition as a framework to navigate complex change processes

Over past decades, even centuries, coal has played a significant role in shaping many regions and the lives of many people across the globe. The start of coal mining generally led to an economic boom for coal regions. Even today, coal industries are still experiencing a steady uprise in some regions (e.g. in Australia and China); however, others have faced quite dramatic transition processes in the last decades, ranging from a decline of heavy industry (including coal and steel) to depopulation (e.g. UK, Germany). These processes have often had negative but also positive effects for the regions, such as improving living conditions, decreasing environmental pollution and health risks, and providing safer and cleaner jobs.

A key takeaway from these historic development processes in coal regions is that *structural change is an ongoing process*. Regional transformations are never really finished – they are stimulated by many factors, and the drivers of a transition can and will change over time. These can include technological developments like mechanisation and digitalisation but also economic trends (globalisation or societal changes (urbanisation)).

Today, in a world that has learnt about the dangers of climate change, one of the new drivers of change are the efforts to limit global warming. This has prompted an urgent call for profound, multi-dimensional change to avoid the most severe consequences such as heatwaves, precipitation and droughts. In consequence, 120 nations across the world have so far so far committed to achieve net-zero greenhouse gas emissions by 2050. Many countries have also committed to phase out coal by the 2030s or 2040s, e.g. at the UN Climate Change Conference in Glasgow by signing the corresponding declaration. Taking into account all current knowledge regarding transitions, the effects of the effects of climate change, today's energy production systems and future development options, it is nonetheless clear that the sectoral and economic transformation caused by climate change is occurring on a scale and within a time frame faster than any other in human history. ***This means we need to start anticipating and implementing the transition as a matter of urgency now.***

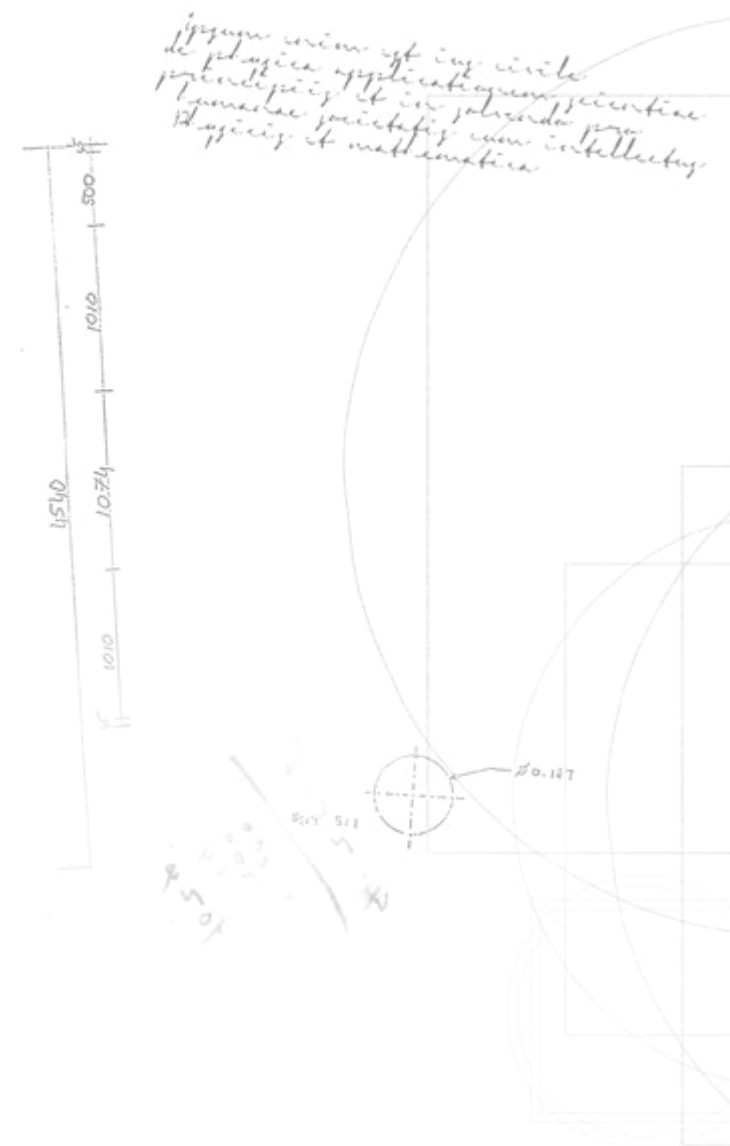

The earlier a managed transition starts, the better

‘Once upon a time, coal brought cheap electricity to entire regions and vital jobs to communities. Those days are gone’.

António Guterres, UN general secretary, 2021¹

There is no question that coal has boosted the economy in mining regions in the past. Coal used to be the backbone of industrialisation and the basis for today’s wealth in many countries. Planning for the future is not about denying this past. On the contrary, the achievements of miners and the hardships and risks they (and their families) have been bearing need to be acknowledged and valued.

But a look back in appreciation should not stop us from developing a realistic picture of the present and the future. Coal is the dirtiest fuel, both with respect to greenhouse gases and deaths from accidents and air pollution (see figure 1). Coal is also not cheap anymore, as other renewables have become the most cost-competitive energy source in most parts of the world. Ultimately, it is only a matter of time until coal is phased down or completely phased out.

A look at energy plans and climate neutrality scenarios clearly shows that in many countries, there will still be shares of coal in the energy mix in the coming years and decades. Does this mean there is no cause for concern? A look at the old industrial towns and coal regions shows that they are struggling. The Ruhr in Germany, Appalachia in the US – these regions were already facing a decline in coal decades ago. However, unemployment rates in the (former) coal regions are still higher than the national average. Both regions have tried to prolong their coal industries for a long time and have been reacting

to rather than proactively planning the transitions. Another factor these regions have in common is lower economic performance compared to the rest of their countries – and oftentimes, people sense a feeling of disconnection, that they have been left ‘behind’.

What history teaches us here is that **it will always be better to have a managed transition than an unmanaged structural change process**. The remaining carbon budget will put more and more pressure on global coal use in the next years - and given that new jobs for workers, regional economic regeneration, and company’s reorientation towards new business models do not happen overnight, coal regions need to begin a managed and controlled transition, the earlier, the better. Once they begin, coal transitions can move fast, at which point it can be impossible for governments to stay in control, with serious consequences of more abrupt and unmanageable changes.

FIGURE 1 The safest and cleanest sources of energy *Nanticoke Solar, Canadá* What are the **safest** and **cleanest** sources of energy?

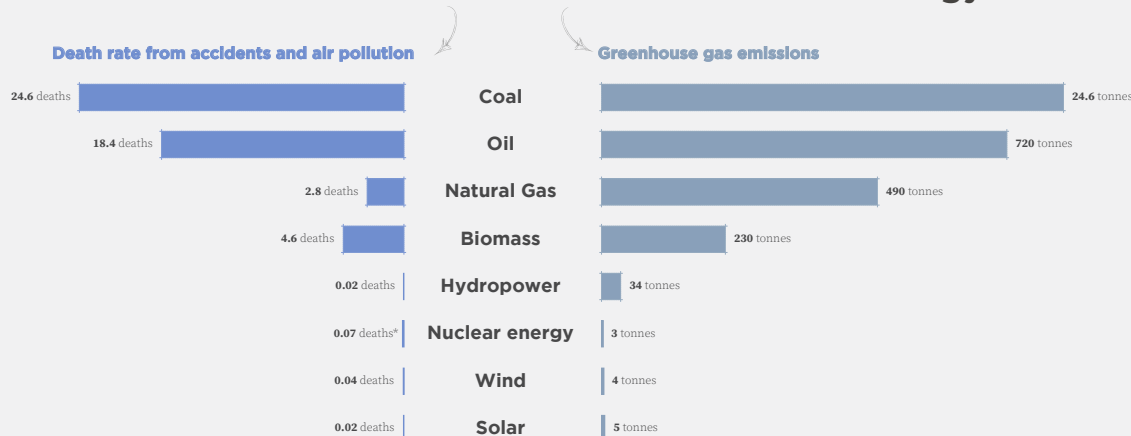

Sources: Sovacool et al. (2016); and Markandya, A., & Wilkinson, P. (2007)

Death rates are measured based on deaths from accidents and air pollution per terawatt-hour (TWh). Emissions are measured as CO₂-equivalents per GWh of electricity over the lifecycle of a power plant.

The transition is a unique window of opportunity

On the bright side, transitioning away from coal and other fossil fuels no longer means pursuing a path into the unknown. Most of the emission reductions through 2030 come from technologies already on the market today. Thanks to years of research and global investments in technological developments, future development pathways e.g. in the energy sector are well-known: there are a range of new renewable technologies that are readily available and technologically mature (see section 3). Even today, wind and solar PV are cheaper than new coal plants almost everywhere, even before considering coal's health, climate and environmental impacts. Of the approx. 2,500 coal plants currently installed worldwide, the global share of uncompetitive coal plants is expected to increase rapidly to 78 percent in 2025 (see figure 2).

New technological solutions and innovations are also ramping up in other sectors. As a matter of fact, more and more people are seeing that **changes towards a climate-neutral future will be inevitable, creating a tipping point that should not be missed**. For this reason, policymakers on all levels should treat this moment in history as a window of opportunity. Phasing out coal not only brings immediate benefits to coal regions by reducing air and water pollution and improving health – the climate crisis can open up the potential to kick off deeper changes that improve the livelihoods of millions of people. For instance, the Global Commission on Climate and the Economy initiative calculated that bold climate action could deliver at least USD 26 trillion in economic benefits through to 2030, compared with business-as-usual. In other words, the next five to ten years will be a unique 'use it or lose it' moment. Of course, not everyone will be clear winners in the coming transition, and some will do better than others, but it cannot be stressed enough that the costs of taking action are far less than the costs of inaction.

FIGURE 2
Cost competitiveness of existing coal vs. new renewables and storage



Source: RMI (2020)

The transition isn't just about the economy, but people

While debates around sustainable transition the global level often focus on overarching goals, trade systems and the economy, the fundamental question is: What does climate change, the transition and its consequences mean for people? The ILO estimated that 6 million jobs in coal-related sectors could disappear by 2030. Many of the potential 24 million new green jobs will require different skills than previous energy jobs or will be in new locations. Overall, climate change will affect everyone – and if this complex transition is not managed in a just and equitable way, it could create unnecessary hardships for affected workers and their communities and even lead to a pushback of crucial climate policies. Therefore, **the transition towards a climate-neutral future can only work if it is a Just Transition**. The Paris Agreement acknowledges ‘a Just Transition of the workforce and the creation of decent work and quality jobs’ as a major challenge and highlights the importance of workers in responding to climate change. Nonetheless, a Just Transition will not happen by itself. It requires comprehensive planning, new and adjusted policies and the involvement of all stakeholders (more on Just Transition on [page 11](#)).

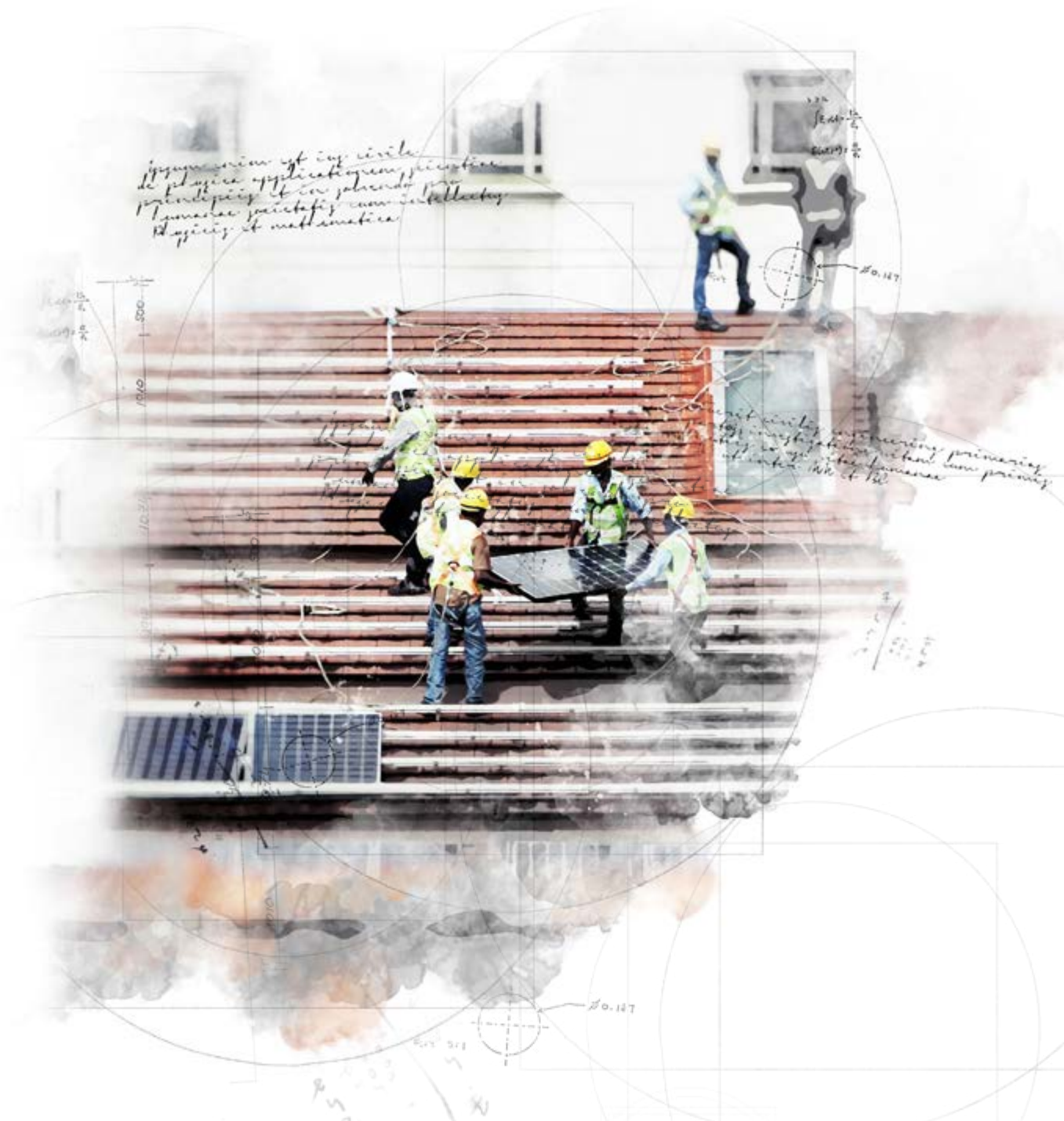

Aims of this toolbox and scope

This toolbox is designed to provide support for practitioners in coal regions across the globe – policymakers in regional administrations, people working in or for ministries and other stakeholders in coal regions, who are or want to be involved in a just (energy) transition process. Individual sections of the toolbox might be also useful for policy advisors, representatives of local and regional governments, social partners at all levels, unions, companies in energy or energy-intensive industries, researchers or organisations operating in the area of community organising, citizen participation and reskilling.

Most importantly, it is crucial to note that there is no *one-size-fits-all* approach. Coal regions differ with respect to many characteristics, such as culture, economy, size and governance systems, as well as finance, infrastructure and knowledge. Densely populated urban regions have different potentials for transitioning compared to rural regions. Some regions have already or are on the way to closing some of their mining sites and power plants, while in other regions a large share of the economy still depends on coal.

To minimise the risk of being too generic, we include examples of current practices in coal regions, including their strengths and shortfalls, to help practitioners learn about what their peers are currently doing. We do this to provide inspiration rather than strict recommendations, acknowledging that designing transition measures in coal regions is an ongoing learning journey for all actors across the globe.

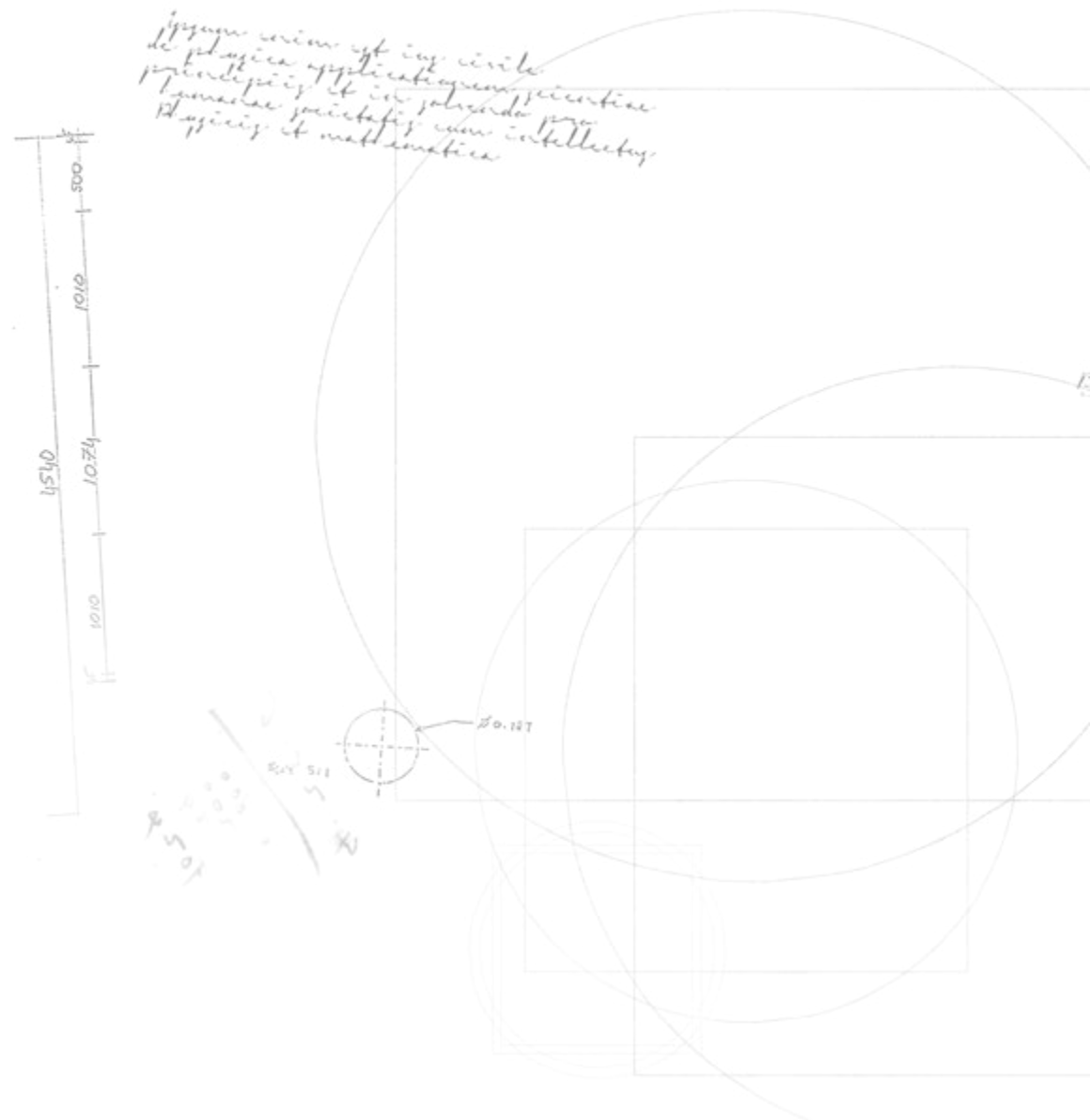

Overview of five main sections of this Just Transition processes

Based on the concept of Just Transition and the basic elements that are need to integrate it in a regional context (see also [page 13](#)), as well as taking into account the learnings and experiences from our work with European coal regions, we have centred this toolbox around five main themes: strategy, governance, energy, industry and employment. Each of the sections can be read individually; in the beginning we highlight some key messages, and in the end, we list further resources such as tools, reports and websites that may help you dive deeper into certain topics.

1. Developing strategies for a just transition in coal regions

Develop a regional transition strategy in coal regions

Identify actions and projects to support the strategy

Monitor, evaluate and continuously adapt the strategy

2. Designing effective governance models

Designing the right governance model to support a transition process in coal regions

Facilitating stakeholder engagement

Enhancing the role of social dialogue and of civil society in the transition process

3. Making the shift from fossil to renewable energy

Renewable energy and storage technologies and their roles for the sustainable transition

(Bridge) technology options with higher risks for stranded assets

Coal-related infrastructure repurposing options for mining sites and power plants

4. Decarbonising energy-intensive industries

Challenges and opportunities for energy-intensive industries

Technology options to decarbonise steel production

Regional hydrogen production and infrastructure

5. Paving the way for new business opportunities and sustainable employment

Skill needs and reskilling for coal regions in transition

Cooperation among stakeholders

Support options for workers who are at risk of losing their jobs

Economic diversification of coal regions as a means for long-term job creation

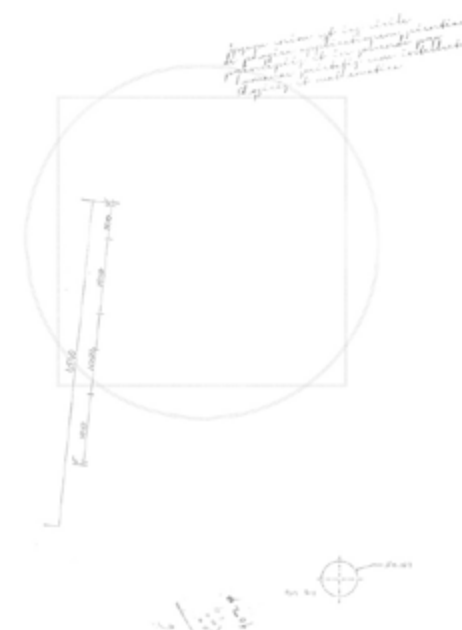

About Just (Energy) Transitions

What is a Just Transition?

Governments, labour groups, investors, business, civil society and multilateral agencies are increasingly using principles of 'Just Transitions' to better understand where the impacts of systemic shifts will be felt and what actions can be taken to best mitigate losses and distribute gains fairly. The utility of a Just Transition lens has come into sharper focus as governments in some countries consider opportunities to channel COVID-19 recovery stimulus packages in ways that structurally transform economies while reducing the risks of climate change and realising the potential of sustainable development.

The key questions that underpin the Just Transitions discourse include:

- Who decides what kind of transitions are needed?
- How are different groups included in the decision-making processes?
- Who benefits and loses in change processes?
- How can benefits be distributed and losses mitigated in ways that are both safe and just?

There are, however, very different understandings of these fundamental questions. In fact, there is no single, universally accepted approach or definition of Just Transitions to date.

Looking specifically at coal regions, the first notion of a Just Transition relates to the coal miners who may lose their jobs if mines are closed. This focus, however, would limit a Just Transition to avoid doing harm and preserving the status quo – which in fact may be perceived as not very just. In consequence, the

discussion expands to include the full coal value chain, the neighbours of the miners, the unemployed and poor in mining regions and how to improve their lives. Or even more broadly, how to increase the quality of life for whole communities, whole regions. ["Categories of different Just Transition approaches" on page 12](#) categorises different Just Transition approaches from status quo preservation to transformation and classifies some approaches and examples regarding their understanding of Just Transition (figure 3).

To make it easier to get grip on the concept of Just Transition, we suggest the following as a working definition: *A Just Transition can be defined as a transition that captures the opportunities of the transition to sustainable, climate neutral systems whilst minimising the social hardships and costs.* In this sense, a Just Transition aims to combine the goals of environmental sustainability, social equity and economic prosperity.

As a matter of fact, time is a key factor for Just Transition. When active management of the transition is started early and the closure of the last mine may still be far in the future, then it is less about the miners (many of whom may retire before the last mine is closed) but about their children and preparing for their future. Even more broadly, climate mitigation is very much about intergenerational justice: will today's adults invest in mitigation – or will future generations have to pay the costs of climate change? From this perspective, it is clear that slowing down the process may initially appear to be an option for decreasing hardships for coal regions but actually does not increase justice.

Taking into account the different understandings of Just Transition, the overall notion of the need for change and the aim to overcome

environmental and social injustice is the common baseline that persists throughout the different concepts. Yet, the process through which a Just Transition could be achieved remains vague.

In consequence, the challenge is not only to break down the concept of a Just Transition to regional circumstances; each region should develop its own concept of what a Just Transition entails and what it means to the country or region. The overview of conceptualisations (see ["Overview about some of the Just Transition concepts" on page 15](#)) may provide inspiration for the visioning and strategic process.

**A Just Transition
can be defined
as a transition
that captures the
opportunities of
the transition to
sustainable, climate
neutral systems
whilst minimising
the social hardships
and costs**

Categories of different Just Transition approaches

Depending on actors' varying beliefs, understandings of Just Transition range from calls to create jobs in the green economy to a radical critique of capitalism and market-based solutions. Analysing different cases of historic transitions and Just Transition concepts, the Just Transition Research Collaborative identified four different kind of approaches that may support an understanding of what kind of Just Transition concept different stakeholders are promoting:

- Status quo transitions:** This understanding of Just Transition is based on a growing concern about climate-related inaction yet does not involve any intention to change the existing rules of how the world works in principle. Led mainly by businesses and corporations, a status quo transition focuses on the potential benefits for businesses and consumers and replacing 'old' with 'new' jobs. 'Just', in this sense, is mainly understood as a transition that creates new employment, without broader involvement of other factors.
- Managerial reform transitions:** A managerial reform approach to Just Transition aims to accomplish greater equity and justice within the existing economic and political system. Certain rules and standards are expected to be changed and new ones can be created, but not by carrying out fundamental reforms. A managerial reform approach is rooted in public policies, stronger investments and social dialogue.
- Structural reform transitions:** A structural reform approach to Just Transition aims to already make deeper changes at the decision-making level by including more stakeholders than the traditional tripartite of dialogue partners consisting of politics, companies and labour unions. It calls for modified governance structures that expand citizen participation so that inequalities and injustices can be more effectively addressed.
- Transformative transitions:** A transformative approach to Just Transition implies an even deeper reform or overhaul of existing economic and political systems. In addition to deep structural reforms, proponents of this approach also promote alternative development pathways that aim to overcome the primarily growth-oriented economic system, together with other systemic structural problems like racism, patriarchy and classism.

FIGURE 3
Mapping of Just Transition approaches

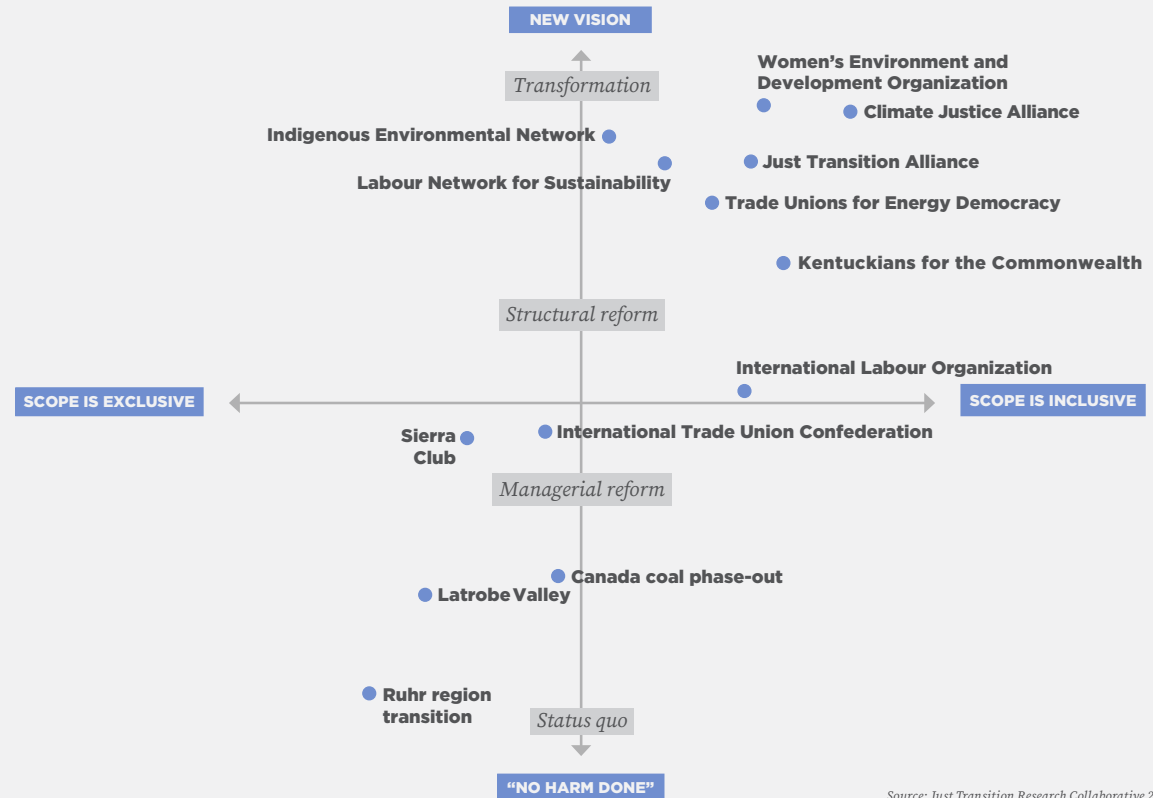

Why transitions must be Just Transitions

Current research on energy and Just Transition agrees that the social and economic transformations required to make the world climate neutral are of a scale and speed unexperienced in human history. Such disruptive change is likely to impact large sections of society, particularly workers and communities reliant on fossil fuels and other natural resources for their livelihoods. If understood as a transition that will most likely not only affect production patterns but people and their way of living, aiming for Just Transition is a moral duty in light of human values such as fairness, equity and inclusiveness (what exactly is considered as fair is yet understood quite differently, see box on [page 15](#)). In order to respect these values, it has to be acknowledged that a prosperous future for everyone cannot be achieved.

This can be also illustrated by imagining what will happen if the transition does not adequately consider Just Transition principles: as unmanaged structural changes in the past have shown (see also Introduction), high rates of unemployment and regional disparities can lead to significant social inequalities between winners and losers of the transition, which bears the risk of strikes, civil unrest and therefore a decrease in overall economic performance and societal well-being. From a political perspective, a Just Transition is therefore not only rooted in moral grounds but also represents a strategy to make climate-related policies more legitimate and can be justified as they prevent the severe consequences of inaction.

As noted in the Introduction to this toolbox, the disruption of structural patterns, triggered by the need to become climate neutral, also presents a unique window of opportunity for positive systemic change. For some, the monumental challenge presented by a climate crisis raised the fear that we might inevitably

have to choose between protecting workers rights or the planet. Just Transition concepts try to overcome that fear by pushing the idea of aligning social and economic development goals. Many climate advocates, countries and trade unions are therefore trying to put the potential positive impacts of transitions at the centre of the debate. And indeed, current research shows that despite facing major challenges, the shift towards a climate-neutral future offers vast potential for positive impacts on several playing fields.

First and foremost, a properly managed Just Transition has the potential to kick off new and better employment opportunities in almost every country and region in the world. An ILO flagship report calculates that 24 million new jobs could be created globally by 2030 if the right policies to promote a greener economy are put in place. In specific areas, such as energy, buildings, food or mobility, action can even lead to ‘triple-dividends’: Measures would not only reduce the ecological footprint but can create new employment opportunities for people with low levels of qualification and increase access to goods and services for vulnerable groups – and therefore help to fight poverty, enhance people’s livelihoods and make societies more resilient. Similar effects can be expected for other areas, e.g. the shift from burning fossil fuels to renewables. This not only has the potential for massive decarbonisation but will also significantly improve the health of affected communities close to power plants and mines as well as that of many households where cooking stoves with open fires are a common way to heat homes and make meals but are a source of negative health effects due to air pollution.

How can a Just Transition be achieved?

As shown in the previous section, the concept of Just Transition is based on a clear understanding of the urgency of climate action to limit the rise in global temperatures to less than 2°C while also recognising the impacts of mitigation as well as adaptation measures on people, especially the poor and marginalised. It will not be easy to achieve these goals of Just Transition – strong political commitment and stakeholder support is needed. In fact, the fundamental lesson that can be learned from previous structural changes is that strong public policy and programmes are needed. Governments play a key role in ensuring success, from supporting innovation, to creating new business opportunities, through to shaping public debate.

Generally, a Just Transition model for coal regions should include the following:

- Functioning governance structures and mechanisms to plan, coordinate, and manage the transition
- A vision and/or strategy that can guide choices and actions in the transition process
- An equity lens to understand the impacts of transitions for women, affected communities and vulnerable groups in particular (see box)
- Coherent plans for the closure of coal mines and coal-fired power plants, including environmental rehabilitation and the repurposing of land and coal infrastructure
- Support for displaced workers with re-skilling and re-employment and realistic training programmes that lead to decent work
- Measures to support economic diversification and development of new green industries

For coal regions, the goal is to bring down the multi-dimensional Just Transition approach to the regional circumstances and customise it to the specific region, its culture and work processes. This toolbox aims to provide an initial overview of the most important aspects of a Just Transition for coal regions. The following elements are some of the most important levers for supporting a Just Transition at the regional level:

- Multi-level, multi-stakeholder engagement with those affected and with those who are part of the solution
- Development of a regional strategy that is based on a landscape of international and national (climate) policies but focuses on the regional challenges and opportunities
- Building capacities in regional public institutions as well as individual capacities by setting up new frameworks and training
- Knowledge sharing processes and adaptation of best practices from other countries and coal regions

IN BRIEF

The gender dimension of coal mining and Just Transition

Coal mining as well as low-carbon transitions have a gender dimension as they affect women differently than men.

The negative consequences of coal mining often have a stronger correlation to fields in which women traditionally bear a high level of responsibility. These include impacts such as water pollution and degradation, health issues due to air pollution (including for children) and land contamination (e.g. used for subsistence farming). A link can also be observed between mining and sexualised violence including child prostitution and trafficking.

Past coal transition processes revealed both opportunities and burdens for women. The coal workforce was and is still predominately male. Massive layoffs of male workers often went hand in hand with an increase in domestic violence. With male miners losing jobs, women increasingly started to pick up paid jobs in order to compensate for the decrease in household income. While this led to increased labour market participation and gave women more financial independence, these jobs were often precarious, low-paid jobs, mainly in the service sector.

Beyond the formal jobs in the coal industry, a large number of people and families in many coal regions in the Global South depend on coal for subsistence livelihoods, gathering and selling coal in local markets. The share of women is much higher here than in the formal jobs, but in many cases, they are not adequately represented in negotiations on coal phase-out e.g., in tripartite social dialogue processes.

In light of this, a truly just energy transition that leaves no one behind has to provide all people – and all genders – with an opportunity to contribute to clean energy transitions. In consequence, it is very important that gender perspectives are systematically included in transition processes in coal regions, especially regarding governance and stakeholder processes see "Designing effective governance models" on page 40) and labour market policies and measures such as job training and qualification programmes (see "Paving the way for new business opportunities and sustainable employment" on page 115). Moreover, investments should be made in research, knowledge generation and capacity building for state institutions with a focus on how to make the transition more inclusive and gender equitable. This also includes facilitating the collection of disaggregated gender data in the field of coal mining and coal transition, which is still relatively rare.

Read more

- > [Gender-responsive climate policy: A case study of the Colombian coal sector](#)
- > [Recommendations of the Global Commission on People-Centred Clean Energy Transitions 2021](#)

Overview about some of the Just Transition concepts

INTERNATIONAL LABOUR ORGANISATION (ILO)

Guidelines on Just Transition

The ILO has been a key stakeholder in driving Just Transition as a term and concept. The ILO's vision of Just Transition is broad and primarily positive, following a systemic and holistic economic approach.

Bridging from today to a future where all jobs are green and decent, poverty is eradicated and communities are thriving and resilient, the ILO stresses the massive development efforts required to reach a zero-carbon economy will create millions of new jobs. But the ILO guidelines also highlight the need to secure the livelihoods of those who might be negatively affected by the green transition.

To manage that transition, social dialogue and collective bargaining between governments, workers and employers is seen as essential. The ILO's '[Guidelines on a Just Transition towards environmentally-sustainable economies and societies for all](#)' can be seen as a major force for the Just Transition concept. It encompasses a range of principles and policy proposals as well as a set of practical tools for governments and social partners in managing this transformation process, focusing on the following aspects: macroeconomic, sectoral and enterprise policies; rights and occupational safety and health; social protection; skills development; active labour market policies; social dialogue and tripartism.

TRADE UNIONS

Conceptual ideas for further development of the Just Transition approach

The *International Trade and Union Confederation (ITUC)* published a comprehensive [policy brief on Just Transition](#), including nine recommended policy areas and provides an exhaustive summary of the developments towards a Just Transition to date, featuring short examples. The ITUC's understanding of a Just Transition follows the ILO's concept above but puts forward ideas on how the concept can be developed further at the end of the paper.

The *Just Transition Centre* was established in 2016 by the ITUC and the ETUC. The Centre brings together workers and their unions, communities, businesses and governments in social dialogue. [Key documents](#) refer to the ILO guidelines with a strong focus on social dialogue: 'A Just Transition secures the future and livelihoods of workers and their communities in the transition to a net-zero-carbon economy. It is based on social dialogue between workers and their unions, employers, government and communities. A plan for Just Transition provides and guarantees better and decent jobs, social protection, more training opportunities and greater job security for all workers affected by global warming and climate change policies.'

The *Trade Union for Energy Democracy (TUED)* goes a step further, demanding a more radical approach focusing on 'social power' instead of social dialogue. The paper below outlines ideas on how to expand public ownership in key economic sectors and institutions.

[-> Read more](#)

UNITED NATIONS FRAMEWORK CONVENTION ON CLIMATE CHANGE (UNFCCC)

Just Transition of the Workforce, and the Creation of Decent Work and Quality Jobs

This paper from UNFCCC presents the general concept of Just Transition, including drivers and objectives, and then discusses the links between Just Transition and the impacts of implementing climate change mitigation policies. It also provides guidance on how to approach Just Transition at the national level. It draws upon several relevant pieces of information contained in reports on the work of the forum regarding the impact of the implementation of response measures, national inventory reports and communications as well as publications by experts, unions, international organisations and research institutes.

[-> Read more](#)

GERMAN ADVISORY COUNCIL ON GLOBAL CHANGE (WBGU)

Just and in-time transition

The WBGU, an independent research-focused advisory body to the German government, proposes a slightly different approach, focusing on the aspects of climate justice under temporal, geographical and social restrictions, combined with a call to act, especially through the creation of financial instruments: 'With a just and in-time transformation, the WBGU aims to combine timely decarbonisation with just solutions for the people affected. This approach takes into account the demand for justice of (1) the people affected by the structural change towards climate compatibility (e.g. in coal-mining regions), (2) the legal rights of people harmed by climate change, (3) the dignified migration of people who lose their native countries due to climate change and (4) the creation of financing instruments.'

[-> Read more](#)

INDIA JUST TRANSITION CENTRE (JTC)

Defining and Framing Just Transition for India

Designed as an approach to bring down the concept of Just Transition to a regional context, the Indian thinktank iForest launched a dedicated Just Transition Centre to enhance understanding of Just Transition from a Global South perspective. Based on an assessment of prior Just Transition frameworks and taking account of regional challenges in India, the JTC defines Just Transition as an 'equitable and inclusive socio-economic development process aligned with the goals of phasing out fossil fuels and transforming fossil fuel dependent sectors to achieve net-zero emissions, building a green economy, ensuring energy justice, securing universal livelihood and social welfare, eradicating poverty and deprivation, building resilient communities and ensuring environmental justice and social equity'.

[-> Read more](#)

Further resources

International Institute for Sustainable Development (2020): Real People, Real Change Strategies for just energy transitions

This report aims to support governments of both the Global North and Global South in their endeavour to make energy transitions just. It focuses on political and communications strategies for a Just Transition, building on research and case studies of energy transitions that have happened or that are happening in Canada, Egypt, Indonesia, India, Poland and Ukraine.

[-> Read more](#)

Grantham Research Institute on Climate Change and the Environment (2018): Climate change and the Just Transition – A guide for investor action

This guide illustrates the Just Transition concept from an investor's perspective, especially for those with economic, social and governance (ESG) values in mind. It elaborates how investors and companies may engage in regional stakeholder involvement processes to identify the needs of workers and communities and to identify ways to support Just Transition programmes at a subnational level. All of these issues are highly relevant especially for regional governments in coal transition regions.

[-> Read more](#)

World Bank Group (2018): Managing Coal Mine Closure: Achieving a Just Transition for All

This report reviews the World Bank's activities related to coal regions and provides nine lessons for the energy transition in coal regions. Specifically, the lessons in Pillar 2 – People and Communities – present a systematic approach for handling the loss of employment in coal regions, which includes pre-layoff planning and pre-layoff assistance. This framework enables the government to coordinate social response strategies to incorporate a broad range of people in Just Transition process, such as not only coal workers but also those working in ancillary industries; women's issues; labour mobility and re(training) skills development.

[-> Read more](#)

Stockholm Environment Institute (2020): Distributional impacts of mining transitions: learning from the past.

This paper examines the gender and age implications of historical mine closures to provide information on current and future energy transitions. It analyses the vulnerability of those who are impacted by the closure as well as the effectiveness of implemented policy responses towards those social groups.

[-> Read more](#)

World Resources Institute: Just Transition and equitable climate action resource center

The WRI hosts a dedicated website that lists a range of good practice case studies in the field of Just Transition, focusing on initiatives by governments, communities and companies that provide lessons for how workers and communities can benefit from the transition to a zero-carbon economy.

[-> Read more](#)

Trade & Industrial Policy Strategies (TIPS): Just Transition knowledge portal

The South African research institution TIPS has curated an open knowledge portal with relevant support materials regarding Just Transition in South Africa. The portal includes short summaries and main takeaways of a variety of reports, strategies, videos, and podcasts. The knowledge portal currently has a focus on South Africa but is expected to be extended to other regions in the future.

[-> Read more](#)

Lochner et al. (2021): Coal and Energy in South Africa: Considering a Just Transition

This book examines the transition away from fossil fuels in South Africa regarding social responsibilities, inequalities, and sustainability. Additionally, it examines the local realities of a coal-producing town in South Africa, Emalahleni, to understand whether a just transition to cleaner energy sources is possible and what implications this global restructuring of the energy industry will have on the local level.

[-> Read more](#)

*ipsum enim est in civitate
de physica, mathematica, scientia
principia et in solvendo pro
omnibus scientiis, non intellectus
logicae et mathematicae*

$$\frac{1}{2} \pi r^2$$
$$E(h) = \frac{r}{2}$$



*Facit enim ingenium primario
partes investigandi, et non primario
investigandi, sed in hoc, in hoc, in hoc
et in hoc, in hoc, in hoc*

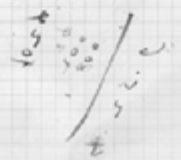

1

Developing strategies

for a Just Transition in coal regions

KEY MESSAGES

A regional transition strategy guides choices and actions in the transition, enabling the various stakeholders and decision-makers to align actions to form a coherent and effective approach.

Transition strategies combine short-term goals with the long-term goal of climate neutrality. This distinguishes them from traditional regional development plans.

An idealised process for strategy development can be structured around four steps: problem analysis and agenda-setting defining visions and objectives; identifying options and implementing actions; monitoring and adaptation.

Effective Just Transition strategies require the involvement of all affected stakeholders and communities from the early stages

Why do we need transition strategies?

Structural changes, as a symptom of transitions, are not a new phenomenon: in fact, production patterns, political landscapes and societies as a whole have been changing as long as they exist. Historically, systemic transitions often happened unplanned and as consequences of new technological developments such as the steam machine or, in the case of former coal transitions, due to the relocation of industries. The transition towards a climate-neutral future, however, is a foreseeable development that has been researched and explored for years. By developing scenarios for a climate-neutral future (e.g. the [IEA net-zero by 2050](#) scenarios) and technological pathways for different sectors that lie ahead (e.g. renewable technologies), we have the opportunity to manage this transition actively and with foresight. While inaction might appear reasonable in the short-term, examples from the past have proven that unmanaged transitions have negative, and in some cases devastating consequences, especially for workers and vulnerable communities. In the UK, for example, the lack of anticipation and active management of the decline in the coal mining industry in the 1980s has led to regional unemployment rates that are 3 to 6 per cent higher than the national average, even 30 years later. In Germany, the government prolonged the lifetime of the declining hard coal industry with around [EUR 289 – 331 billions of subsidies](#) between 1950 and 2008. –This did not prevent the transition but rather placed additional costs on society – resources that could have been used more effectively elsewhere.

With these historical learnings in mind, taking a strategic approach to planning the coming transition ahead of time is crucial to keep up with the complex characteristics of systemic change processes. While there are certain overarching principles, the actual framing should be country- and region-specific, taking local socio-economic and political characteristics into account.

Regional transition strategies in particular are an essential element of a Just Transition as they can guide choices and actions in the transition process and provide planning security to workers, industries, investors and communities. Dialogue and participation are already key elements in the process of strategy development. Workers and communities, along with the general public, need to know which changes are expected to take place who will be affected and what can be done when in response. The various elements of a robust strategy should combine responses to short-term needs with long-term aspirations. They need to be supported by national energy and climate policies that are consistent with international climate commitments. Transition plans should focus on the sustainable development of an entire region to diversify its economy, strengthen social services and increase quality of life.

The following section offers an overview of key elements of strategy development, from analysing problems to defining objectives and selecting actions, to evaluation and eventually policy adaptation. As there is no one-size-fits-all approach, this section focuses on the process of developing a strategy and not the content of the strategy. A deeper look into the governance models which could be set up to develop transition strategies (including stakeholder engagement and social dialogue) can be found in ["Designing effective governance models"](#) on page 40.

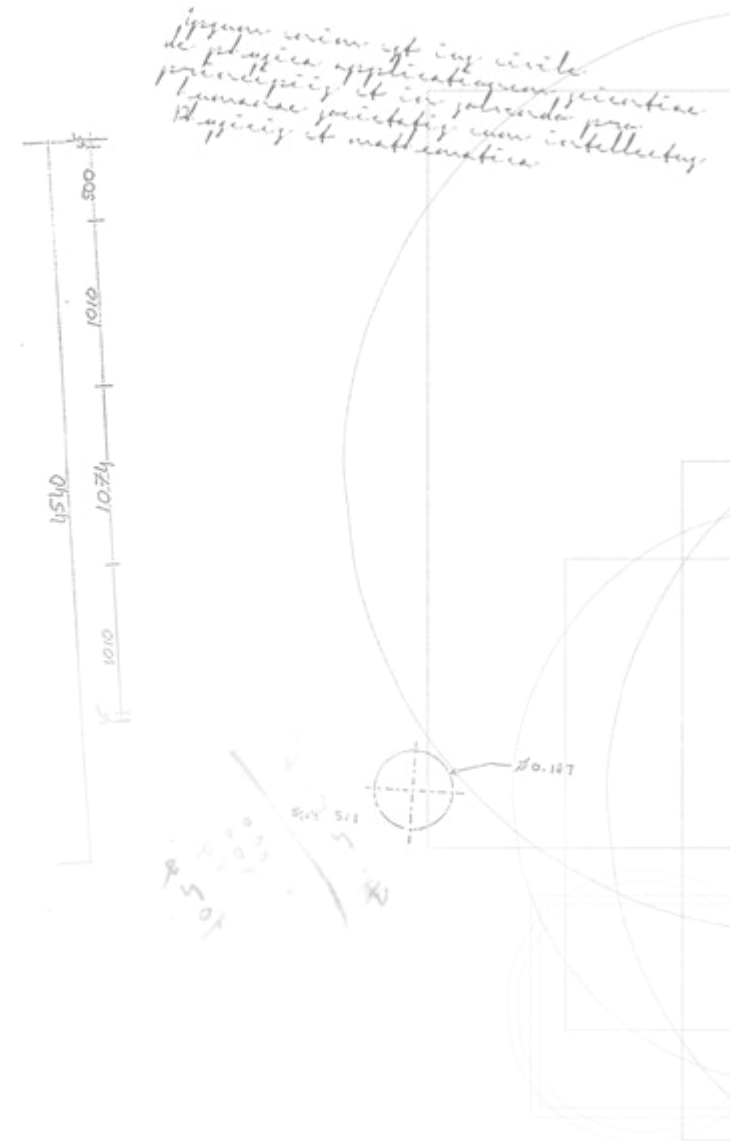

Chile Long-Term Climate Strategy (LTCS)

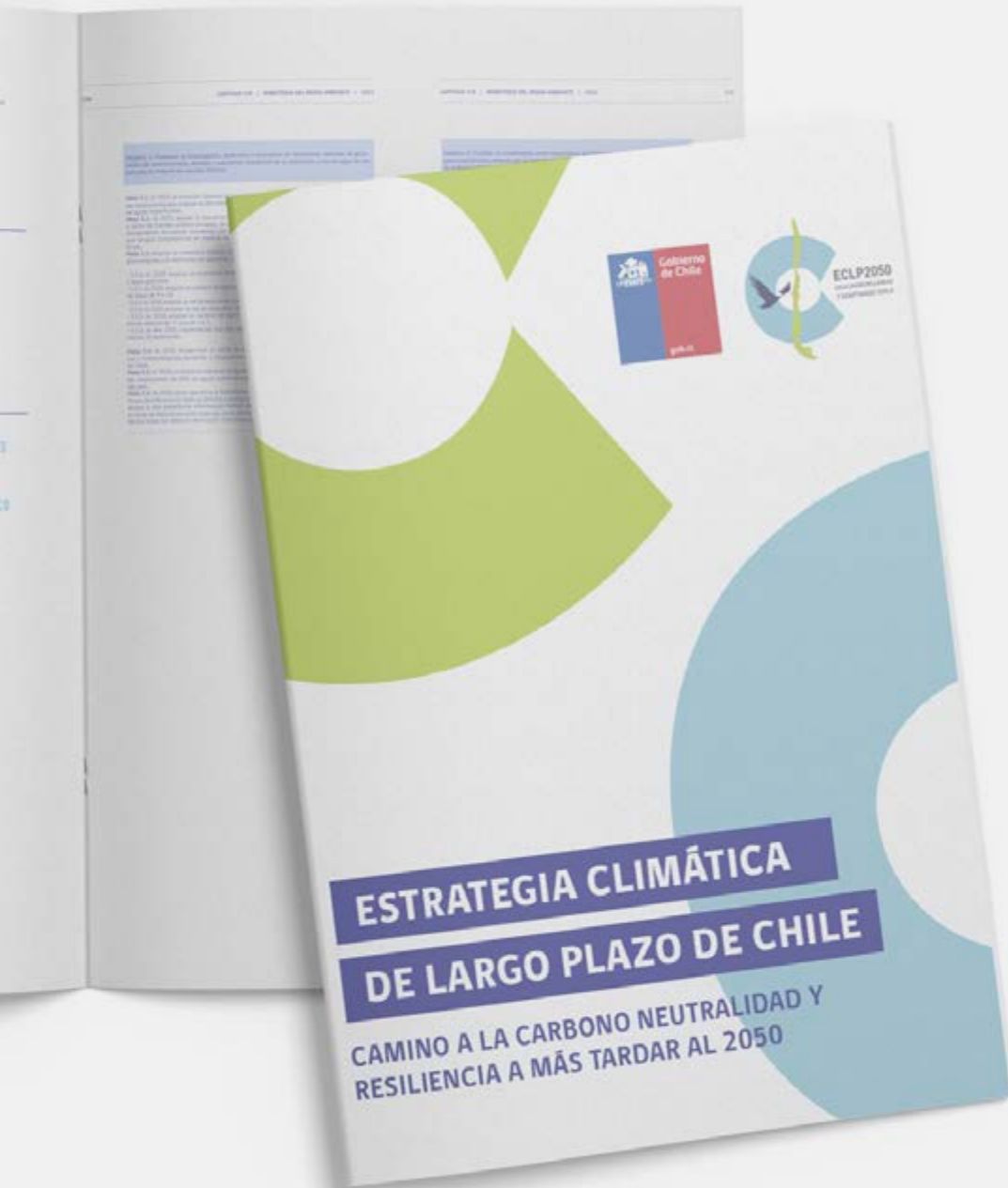

CHILE

Climate change strategies and legislation are taking into account broader public consultations and Just Transition principles

During 2020–2021, Chile developed a Long-Term Climate Strategy (LTCS), which establishes the basic guiding principles for the country's future development. The LTCS is part of a broader package which builds on previous goal-setting within the Nationally Determined Contributions (NDCs), specifying the development pathways for the next decade until 2030, including a phase-out of coal and a first mention of Just Transition as a guiding principle. Chile also developed a Just Energy Transition Strategy, which guides the retirement and repurposing of coal-fired power plants, as well as a Climate Change Law that translates initial parts of the strategy into binding legislation. Generally speaking, Chile's long-term climate strategy sets out the goal of becoming climate neutral by 2050 and emphasises the creation of sectoral carbon budgets as well as sectoral targets. In contrast to the LTCS of other countries, the Chilean strategy also explicitly mentions Just Transition as one of the main five pillars of the strategy as well as incorporating broader stakeholder involvement in the strategy process itself. The LTCS was developed in close cooperation with stakeholders from the public sector, local authorities, civil society, social organisations, young people, indigenous peoples, trade unions, the private sector and academia. Additionally, the Long-Term Climate Strategy will be updated every 10 years based on a multi-sectoral and multi-stakeholder participatory process.

The process of preparing the LTCS has received additional technical and financial support from various international organisations such as the World Bank, the Inter-American Development Bank, the Economic Commission for Latin America and the Caribbean (ECLAC), Euroclima+, Global Environment Facility, GIZ, NDC Partnership, UN Environment, UNDP and others.

The policy cycle

This section on transition strategies is structured along a simple version of the ‘policy cycle’. The policy cycle is a robust and established framework that helps practitioners structure and plan their actions.

The steps of the (simplified) policy cycle are:

- The problem: defining the problem and agenda-setting
- The target: defining the vision and objectives of the strategy
- The action: identifying and selecting options, and implementing actions
- The learning: monitoring, reporting, evaluation and policy adaptation

For different versions of the policy cycle, e.g. the Integrated Management Cycle, see [page 38](#).

Not always sequential

In practice, several steps are often addressed in parallel. For example, an outdated strategy may already exist and actions based on this strategy might be in the process of being implemented, while a new revised version is to be developed.

Most importantly, while optimisation based on an evaluation of experiences comes at the end of each cycle, the basis for this evaluation must be laid out from the beginning by implementing an effective monitoring system from the start.

Not always complete

The policy cycle describes an iterative process and, after completion, it will be started all over again if additional policy action is needed. However, not all steps may be covered completely within one cycle: for example, urgent challenges call for quick action and there might not be time for more in-depth problem analysis. This gap may be filled in the next iteration.

Despite these caveats, the policy cycle is a good structure which can be used by practitioners to develop a transition strategy for coal regions. The following sections describe the strategic choices practitioners need to address at each step as well as examples of current practices and references to other support materials like tools, guidebooks, etc.



Figure 4: The policy cycle

Source: Own depiction

The problem

Defining the problem and agenda-setting

Defining the problem is an important step in the agenda-setting process and will largely define the next steps, including what an appropriate strategy and suitable actions are and which stakeholders need to be involved. Choosing a narrow focus runs the risk of only taking a partial approach to addressing the problem and not doing so holistically (e.g. only addressing symptoms but not root causes, or only short-term but not long-term needs). Choosing a wide focus presents the risk of decision-makers being overwhelmed by the complexity of the problem and the views and opinions to be considered. It can seem that endless discussions are needed before action can take place.

Consulting with a wide range of stakeholders can help define the problem in a more holistic way and ensure that not only a subset of problems is addressed. Expanding the scope to broad-based consultation is even more important, because a narrow definition of the problem may be misleading when identifying key stakeholders.

For example, if the problem is framed as ‘the future of today’s miners’, then government, mining companies and trade unions can be considered key stakeholders. If the problem is framed as ‘the economic future of our region’ then all citizens of the regions as well as universities, business associations, NGOs and other local actors such as companies, SMEs, start-ups or intermediaries are important to consider as well.

Agenda-setting is a highly political process, and the various stakeholders have different interests when framing the problem – so they generally want to frame it in a way that aligns with their key interest.

One key aspect in coal transitions is that the transition is often perceived as being driven by exogenous factors: the region is affected by processes and changing framework conditions from outside the region. Specifically, decarbonisation is a driver, which is directly linked to deliberate decisions by policymakers (e.g. ‘bureaucrats’ in the national capital), which contrasts with changes in economic framework conditions such as market forces reducing the competitiveness of some coal regions.

As a result, local stakeholders may feel powerless, narratives of ‘losers’ and ‘victims’ may emerge (which can result in determined efforts to safeguard the status quo at potentially high costs, e.g. subsidies), whilst generating barriers that stand in the way of developing solutions in a constructive, creative and forward-looking manner. For this reason, ownership of the agenda-setting and problem formulation is highly important and needs local leadership.

Finally, describing the problem in a holistic way does not necessarily imply that all aspects of the problem need to be addressed at once. Sometimes, it can be helpful to define different processes in which the various problem fields are to be addressed. For example, in many mining regions, the population is strongly divided into pro-coal and anti-coal factions (e.g. miners afraid of losing their jobs argue in favour of coal, while homeowners who face the threat of their houses being demolished in open pit mining extensions, or parents afraid of air pollution and health risks for their children, may argue strongly against coal). However, both factions could join forces if the agenda were to be: ‘Today, we will not discuss the future of coal, but how we can create a region that we want to live in.’



Defining the problem will largely determine the next steps regarding strategy, stakeholders, and actions

Getting the facts right: information to be gathered

Starting to define the problem may quickly lead to the realisation that more knowledge and certain facts will be needed to provide solid arguments. In fact, the whole strategic planning needs to be based on sound knowledge concerning regional challenges, facts and figures. However, gathering information is a long-term process that requires skills, institutional capacity and cooperation between different stakeholders. Often, data does exist but is fragmented and not easily comparable. As a result, gathering and assessing information needs to be undertaken as an iterative process with a short-term perspective: key facts need to be gathered and analysed – to serve as a basis for the first cycle of strategy development. At the same time, long-term processes should be set up in order to provide input for the implementation and adaptation of the strategy (future policy cycles). This includes gathering and assessing missing data, and continuously updating the most important data.

A key strategic question for regions at this point is ‘make or buy?’. There are pros and cons to each option. Outsourcing data analysis can help to speed up the process but developing dedicated capacities in the regions supports longer-term prospects. Decisions need to be made based on the specific situation in the region. However, building local capacities (in administration, nearby universities, research institutes and the local private sector) should be part of any regional development strategy.

Gaining knowledge of the region’s assets is crucial, as strategy development must be based on the region’s conditions and reflect the existing opportunities. This phase should yield thorough knowledge regarding the region’s strengths and weaknesses. Furthermore, each region needs to identify innovation

GOOD PRACTICE



FIGURE 5
OPI-TPP website

Source: OISIP województwo silesia

Information platform for post-industrial and degraded areas in Silesia, Poland (OPI-TPP)

In Silesia, Poland, the Marshal’s Office of Silesia Voivodeship, in partnership with the Central Mining Institute (Główny Instytut Górnictwa-GIG) developed a data source on abandoned industrial sites, the Information Platform for post-industrial and degraded areas in Silesia (OPI-TPP), after realising that new companies often struggle to find a good location to settle in.

→ [Read more](#)

bottlenecks and challenges for both society and the economy. To form a robust development strategy, however, it is also necessary to look beyond the region itself and understand its position compared to other regions. This can further an understanding of whether it is better to specialise in a certain area, collaborate with other regions with similar economic structures or adjust the region's priorities.

An in-depth understanding of the region is the backbone of every strategic development. The question is: what kind of information and data needs to be gathered, and how do we analyse these insights? This process is determined by various restrictions, such as time, funding, etc.

Generally speaking, an analysis of the context should be based on:

- Geographic characteristics relating to the size and extent of the region but also on the type of mining and natural assets.
- Social and demographic factors, including information about employment and the labour market as well as a vulnerability mapping, to determine who is most susceptible to the impacts of climate change¹.
- Economic characteristics, including technical and knowledge infrastructure.
- An institutional setting which provides a framework for the possibilities of development led by decision-makers.

¹ This should include both adaptation and mitigation measures, addressing intersecting variables such as income, gender, caste/race/ethnicity, disabilities, marital status and other parameters.

TOOL

FIGURE 6
EQuIP tools overview

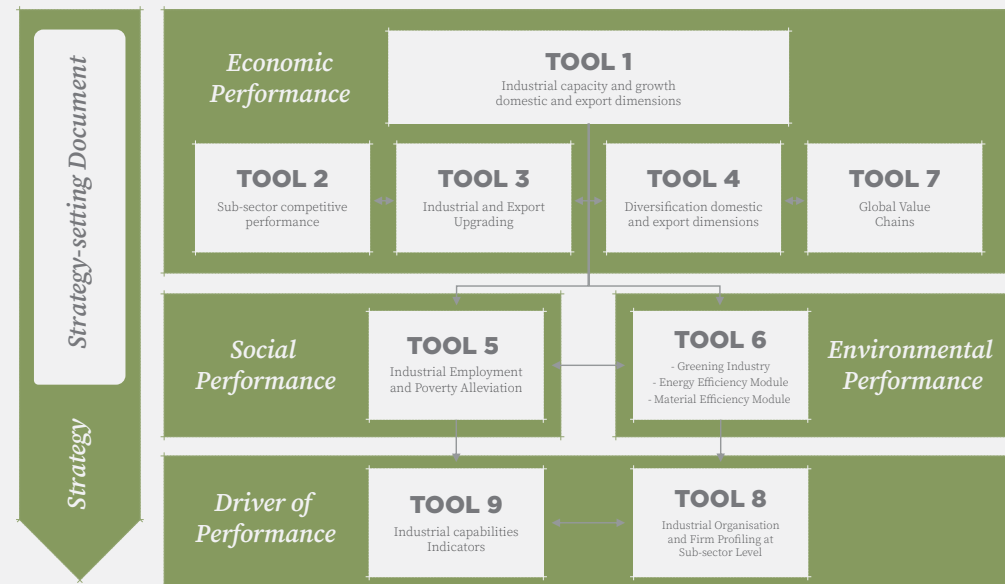

Source: GIZ/UNIDO

Tools to gather key information for regional development

The EQuIP toolbox comprises globally available industrial performance and capability measurement approaches, targeting countries in the Global South. The EQuIP tools offer stakeholders a range of methodologies to consider for industrial diagnosis and strategy design in their countries. It covers topics such as industrial growth, sub-sectoral competitive performance, diversification, productive employment generation and greening of industry.

Another helpful tool is the ONLINE-S3 toolbox, which covers seven sub-tools that are designed to help aggregate and compare regional profiles and indexes with already existing data but also to identify research infrastructure that can help to analyse the context (see also further resources).

This core stocktaking will provide policymakers with a solid database to understand the strengths and weaknesses of the region. Several analysis methods, both quantitative and qualitative, are available to make use of all the information and can promote an understanding of the status quo, including the coal value chains and economic interconnections as well as the region's future potential. Examples include:

- SWOT analysis
- Market analysis
- Value chain analysis
- Dynamic shift-share analysis
- Comparative advantages analysis / 'Porter's Diamond'².

Some of these methods have been previously used by different regions to understand their potential for transition strategies.

GOOD PRACTICE

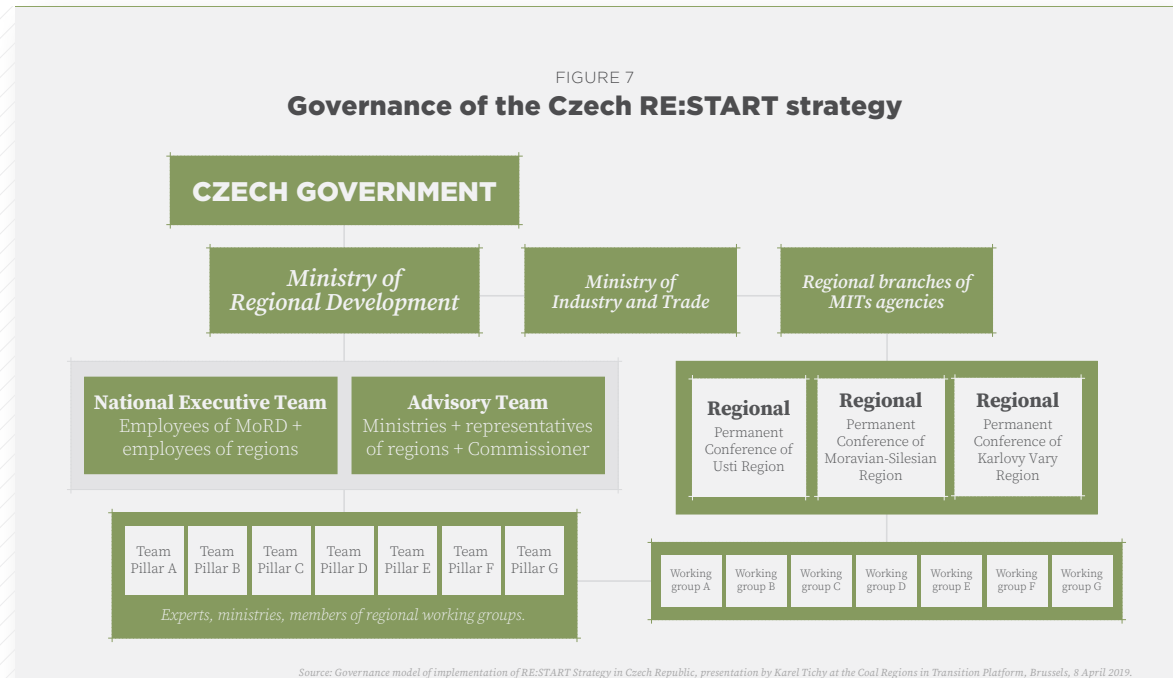

The Czech RE:START strategy

Differences between coal regions within one country is also something that has been acknowledged in the Czech RE:START strategy. RE:START is one example of a national strategy process for the regional development of coal mining areas.

The Czech government has made it its objective to develop a single common strategy under the leadership of the national Ministry of Regional Development. But it was also clear that expertise on the specifics of the regions lies with experts from the regions. And that furthermore, even within the Czech Republic, the three coal mining areas do in fact exhibit substantial differences with respect to socio-economic characteristics, specific challenges and possible solutions. As a result, a governance structure has been devised that matches national institutions with regional counterparts, acknowledging each region's specific needs and potential.

→ [Read more](#)

² Also known as the 'Theory of National Competitive Advantage of Industries', Porter's Diamond is a diamond-shaped framework that focuses on explaining why certain industries are innovative and competitive internationally, whereas others might not. It is framed by four pillars of analysis: firm strategy, structure and rivalry, related supporting industries, demand conditions, and factor conditions.

The target

Defining a vision and objectives

A transition strategy needs to specify its target with respect to the direction in which it wants to develop. This should include:

- **A long-term vision:** given that transition and structural change processes generally take several decades, a vision should be aligned with the desired state of the region in 25–30 years. A vision is generally qualitative and describes a narrative, and often makes reference to the specific heritage and/ or cultural identity of a region;
- **Development objectives:** the general vision should be underpinned by clear objectives. These objectives should be more concrete and can address a shorter time frame (e.g. 10 years).

Vision and development objectives need to be region-specific and must be aligned with local framework conditions. Furthermore, the vision and objectives need to be in line with existing development goals. This includes the international climate objectives of the Paris Agreement, the Sustainable Development Goals of the Agenda 2030 (SDGs) and other national or multinational legislation and strategies. This specifically means that both the long-term visions and short-term objectives need to be in line with a zero-carbon pathway before 2050.

International sustainability pathways

The Paris Agreement

The Paris Agreement sets out a legally binding global framework to limit global warming to well below 2°C and pursue efforts to limit it to 1.5°C. This means the world has to stop emitting more greenhouse gas emissions and eventually become climate-neutral. Generally, the Paris Agreement can be described as the most important climate agreement at the global level and the baseline for all activities in the context of sustainable transitions.

Vertical integration of these goals takes place via nationally determined contributions (NDCs). The nationally determined contributions or NDCs function as self-defined climate plans by respective countries and should define the measures to reduce greenhouse gas emissions according to their national circumstances. To better frame the efforts towards the long-term goal, the Paris Agreement also invites countries to formulate and submit long-term climate strategies (LTCS or LT-LEDS).

UN 2030 Agenda / Sustainable Development Goals (SDGs)

In 2015, the United Nations formally adopted the [2030 Agenda for Sustainable Development](#), along with a set of 17 SDGs and 169 associated targets. The goals can be applied at the national, regional and local levels. For example, the SDG's sub-targets of 1 (no poverty), 3 (good health and well-being), 5 (gender equality), 7 (affordable and clean energy), 8 (decent work and economic growth), 10 (reduced inequalities), 11 (sustainable cities and communities), 12 (responsible consumption and production) and 13 (climate action) and 15 (life on land) may be especially relevant for the development of a vision for coal regions.

The EU Green Deal

In 2019, the European Commission launched the EU Green Deal, which aims to be a new strategy for the EU to become climate neutral by 2050. In order to deliver this goal, the plan includes updated and more sustainable EU policies (e.g. the [circular economy action plan](#) and the [Farm to Fork strategy](#)) as well as investment support mechanisms to further push green technologies, sustainable solutions and new business opportunities. Under the EU Green Deal, the European Commission also makes a special commitment to assist coal, peat shale and oil regions. For instance, the [Just Transition Mechanism \(JTM\)](#) will provide targeted support to regions and sectors that are most affected by the transition towards the green economy.

Powering Past Coal Alliance (PPCA)

The [PPCA](#) is an initiative of almost 170 members including 48 national and subnational governments as well as 69 businesses and organisations that aims to accelerate the phase-out of unabated coal power generation. The PPCA encourages a global moratorium on the construction of new unabated coal-fired power plants and aims to shift investment from coal to clean energy, achieving a coal phase-out in a sustainable and economically inclusive way.

The process of how to develop a regional vision and define development objectives will also vary from region to region and will significantly depend on the respective structures and understanding of what good and effective governance is:

- **Leadership and political mandate:** a visioning process needs high-level political buy-in from the very beginning. The institutions that will be responsible for implementing the strategy will need to lead the process (or mandate the lead to a chosen representative or facilitator)
- **Stakeholder engagement:** to achieve a Just Transition, engaging a broad variety of stakeholders in the process of developing a vision and identifying objectives for the transition process is crucial to make the results more robust (integrating more views and knowledge). At the same time, stakeholder and community engagement already represents the first step towards implementation. A strong sense of ownership among a broad array of stakeholders ensures buy-in and support. This is especially important as structural change is a long-term process over several decades. The more stakeholders are involved in the strategy, and the more diverse they are, the better the chances are of the implementation continuing effectively even when the elected government changes
- **Tools and facilitation:** developing a good vision and objectives, especially when this is to take place in a participatory process, requires methodological skills and a dedicated facilitator.

TOOL

FIGURE 8
The Amsterdam city doughnut



Source: [Doughnut Economics Action Lab](#)

Amsterdam City Doughnut – a tool for transformative action

Setting a new basis for its future development, the city of Amsterdam presented a ‘city portrait’ that applies the economic ‘doughnut model’ for problem analysis and defining a vision. The main goal of this approach is to re-frame economic problems in a more holistic way: an economy is considered prosperous when all social foundations are met without overshooting any of the ecological ceilings.

In the Amsterdam model, the inner ring of the doughnut represents minimum standards of living, based on the UN’s Sustainable Development Goals, comprising basic essentials such as access to food, clean water, gender equality and adequate housing. The outer ring of the doughnut represents the ecological limits of the planet, from biodiversity loss and air pollution to climate breakdown. The space between these two rings represents the possible actions that respect both social and economic boundaries.

The assessment of these variables provides a holistic snapshot of the city’s strengths and weaknesses and, together with the outlined boundaries, forms an overarching comprehensive, yet ambitious vision for future development. The model shall now serve as a tool to support the city’s policymakers in identifying (policy) actions.

The action

Identifying strategic options

Once a long-term vision for the region is created and concrete development objectives are defined, strategic options addressing how these objectives can be reached need to be identified.

In practice, the process of identifying options and defining objectives often goes hand in hand, in smaller iterative loops: in order to define where a region wants to go, it is necessary to know where it could go. Scenarios (see box) are one approach of exploring options for future development and analysing which likely consequences or impacts certain actions may have. Scenarios are often combined with backcasting in order to identify pathways to reach a desirable future. The first step is roughly sketching what a desirable future for the region would look backwards. The desirable future can be described in broad terms, using images or analogies that relate to the specific region. Pathways and steps which address how this desirable future can be reached are then identified in an iterative process. More information on backcasting methods can be found in the [Climate-KIC visual toolbox](#).

There are simpler approaches of identifying options for action than developing scenarios, such as collecting options in interviews, conducting discussions rounds, consulting with experts or transferring international examples of good practice. These approaches do have their merits; identifying options generally requires less effort. In many cases, a great deal of local knowledge exists on what could be done or improved. When there are significant time restraints for the implementation these approaches make it possible to kick-start action on the ground. They can be used to achieve quick wins in parallel to the

TOOL



**Western Macedonia,
Greece**

Scenario techniques

Scenario techniques are a useful tool for developing strategic options and development paths in this process. They help to shed light on the question: 'What would happen if we did xyz?'

- Scenarios can be quantitative using computer-assisted modelling or qualitative, describing possible futures by means of narrative stories or pictures.
- Scenarios should explore a wide variety of futures, including seemingly likely as well as rather unlikely ones, and desired futures and undesirable ones.
- Robust scenario development processes generally do require the support of (methodological) experts like consultants or research institutes.

Example: In Western Macedonia, Greece, scenario modelling has been used in the process of developing a 'Roadmap for the Transition of the Western Macedonia Region to a post-lignite era', primarily to estimate and partly quantify future economic impacts of regional development options. The roadmap certifies positive outcomes for the economic development and job situation for all three scenarios.

-> **Read more**

process of developing a robust and holistic strategy. However, precautions should be taken to ensure that quick decisions do not contradict long-term objectives. This applies in particular for investments in infrastructure that may set regions on irreversible, undesirable development paths or cause stranded assets.

Two established approaches for identifying options in a more strategic way are the **Logic Model** and the **Theory of Change** (see further resources). Both aim at describing potential processes from intervention to results. This analytical process promotes a better understanding of how certain objectives can be reached. Often displayed as an impact chain, logic models and theories of change do not have to be linear but can (if applied well) also be used to identify correlations between different measures (synergies, gaps in strategies, etc.). They can be combined with scenarios as well as backcasting and can be used in, or developed within, participatory processes.

Be creative and engage with many experts and stakeholders

Exploring possible options needs to be a creative process. A key aspect is to not zoom in too early on a small number of options but to start thinking outside of the box. There are a wide variety of techniques that support creativity in this process (e.g. the Design Sprint method, see further resources). Again, it is also important to include different views and perspectives. Options should not only be identified by a small number of ‘insiders’ but should make use of the knowledge and ideas of a broad mix of stakeholders (more on participatory planning can be found in ["Designing effective governance models"](#) on page 40).

At this stage, there is the risk that powerful actors of the ‘old’ system will dominate the discussion and bring forward ideas that predominantly help to preserve the status quo instead of looking for new opportunities. At this point, it might be helpful to involve ‘outsiders’ like artists, experts from very different fields or ‘neighbours’ to spark the imagination. Finally, creative processes do need professional facilitation. This is truer in environments where strong imbalances due to power, resources and expertise exist.



Identifying finance options

Finance is a key issue when it comes to implementing a Just Transition. Turning transition strategies and plans into projects and mobilising resources to support projects can be a major challenge for coal regions in transition, in particular for regions in the Global South and organisations working at the local level, which often face a ‘*pipeline development problem*’. Despite potential policies and strategic planning, early-stage financing for projects is often hard to acquire, bringing the overall transition to a halt in the very first step. A transition strategy should therefore include a dedicated financing strategy that takes fiscal measures into account right from the start.

Designing an integrated transition financing strategy includes:

- Prioritising sectors with the greatest financing gaps and/or greatest possible impact.
- Alignment with the broader investment, fiscal and financing strategies of the region, including infrastructure investments.
- Identifying capacity needs for mobilising finance.
- Developing a flexible vision for the evolution of the financing mix in the region.
- Monitoring the performance of the region in attracting different financing flows and meeting its financing strategy goals.

As funding sources will differ substantially according to the country, region and even individual projects, coal regions should ensure first and foremost that project developers, local administrations and other stakeholders know where they can access support. Figure 9 provides an initial overview of international financing options and technical support schemes.

IN BRIEF

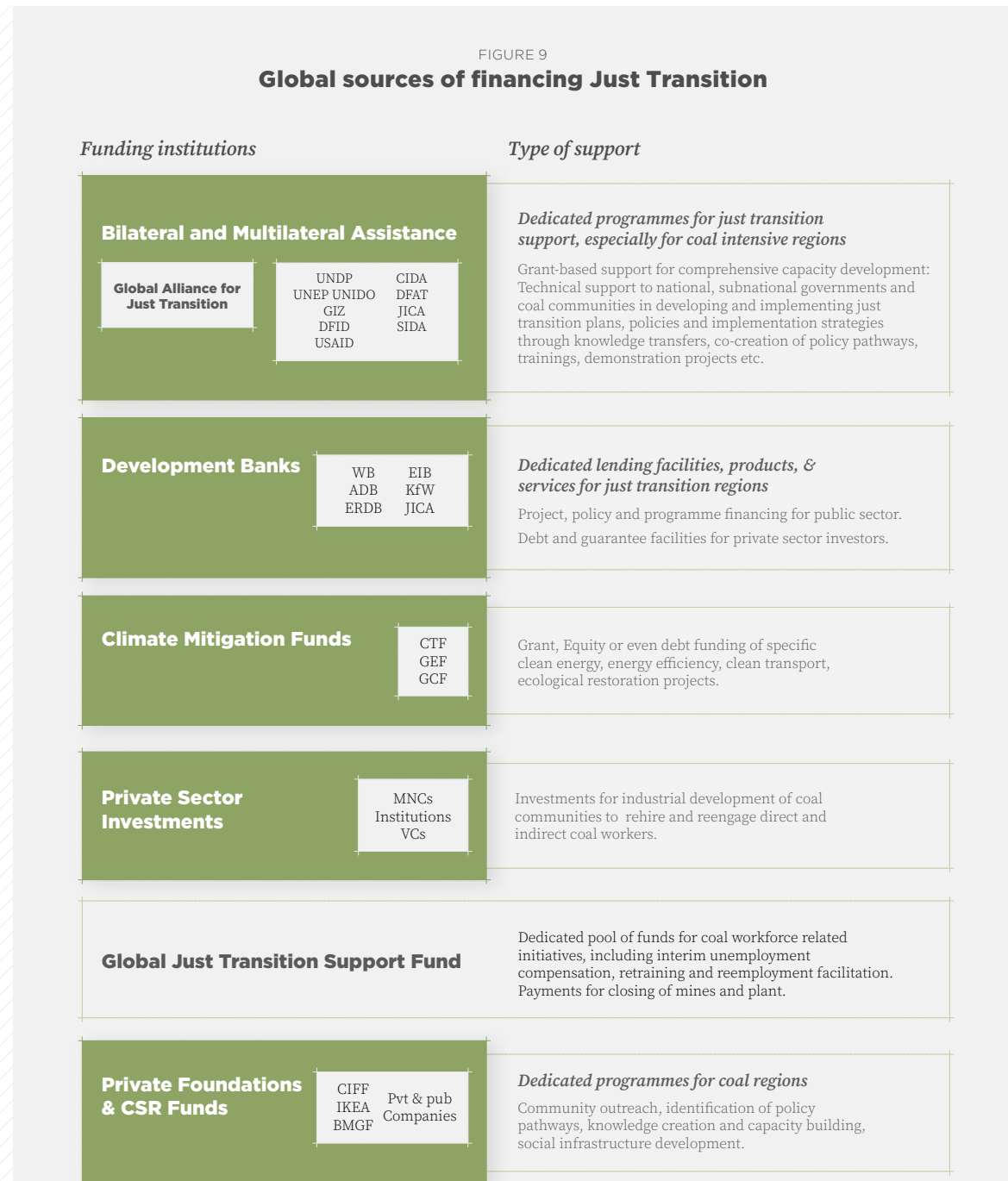

Selecting options and activities

After the options have been explored, it is time to hone in on concrete actions to be taken. Some processes are thoroughly designed from the overall objective to specific actions and formulated as a roadmap in which the desired state is operationalised by measurable targets and timetables. Other processes simply define an overall vision and then support a multitude of individual projects which contribute to these frameworks. Both processes have their pros and cons. However, measures need to be put in place to ensure the second approach does not become arbitrary.

Risks and challenges

New approaches often lack protagonists with a strong institutional capacity. For this reason, the whole project can be fragile and should be managed with an awareness of the following risks and challenges:

- **Conflicting targets:** as a vision for regional development generally comprises various targets, individual actions will most likely support one target more effectively than others or have adverse effects. Those conflicts with respect to the various objectives result in the need for trade-offs, which in most cases need to be negotiated. On the other hand, potentials for mutual benefits exist and can be tapped by developing new, creative solutions with out-of-the-box thinking.
- **Vested interests:** incumbents and established actors generally have much more extensive bargaining power and often long-standing contacts and means of influence over regional public decision-makers. Thus, there is the risk that they could influence the process of selecting actions to be implemented with regards to their own interests, which do not necessarily match the overall interests of the region. Similar to the

Multi-Criteria Analysis (MCA)

Multi-criteria analysis (MCA), or multi-criteria decision analysis (MCDA) can be a useful complement or an alternative to a cost-benefit analysis. It is particularly relevant at the stage of analysing options, for both assessing the economic, social and environmental dimensions of each option and comparing policy options. Multi-criteria analysis techniques become especially relevant when decision-makers have to handle large amounts of complex information in a consistent way.

MCA techniques can be used to identify a single most preferred option, to rank options, to shortlist a limited number of options for subsequent detailed appraisal or simply to distinguish acceptable from unacceptable possibilities.

MCA has many advantages over informal judgement unsupported by analysis:

- The choice of objectives and criteria that any decision-making group may make can provide an important means of structure and communication and adds legitimacy to the overall process.
- Scores and weights, when used, are explicit, developed according to established techniques and can provide an audit trail. They can also be cross-referenced to other sources of information on relative values and amended if necessary.
- Performance measurement can be subcontracted to experts.

However, the variety of different techniques, often with rather similar-sounding names, is a common source of confusion, and some kinds of MCA do not presently offer much help for practical decision-making. For further information, the guidebook 'Multi-criteria analysis: a manual for communities and local governments' referenced below provides an excellent overview for practitioners.

-> [Read more](#)

Example: An MCA has been applied in South Africa by the research institute CSIR in collaboration with ministries, power and mining operators as well as international stakeholders to explore the options for repurposing and rehabilitating coal-fired power plant and mining sites in the Mpumalanga region. The framework for the multi-criteria decision analysis builds on regional profiles of the most affected municipalities as well as learnings from repurposing projects in EU countries to identify closure alternatives and criteria for assessing these alternatives. The MCA framework explicitly takes into account Just Transition principles, aiming to cover not only technical, economic and environmental aspects but also societal consequences as decision criteria.

-> [Read more](#)

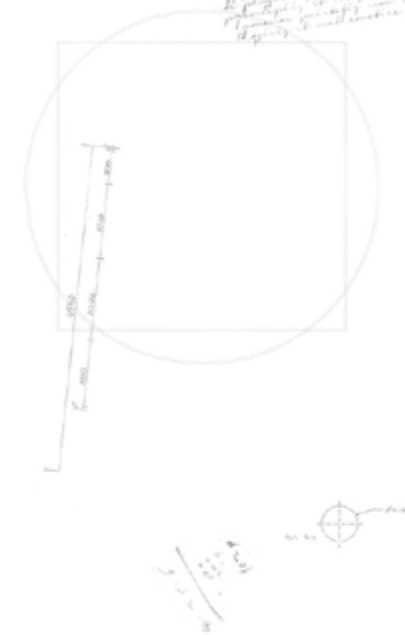

Institutional support and funding schemes which are available for a number of years can help to support more transformative innovation systems

development process of the overall vision and objectives (see "[Defining a vision and objectives](#)" on page 27), there is the risk that actors with fewer resources as well as newcomers have less opportunities to influence the selection process.

- **Lack of innovation:** feasibility should obviously be a key criteria in selecting actions. However, there is a risk that 'more of the same' is systematically preferred over new and innovative ideas, which are by definition less well known and do entail some risk of failure.
- **Institutional capacity:** in fields where extensive public financial support is involved, there is a risk that a certain budget needs to be spent within a certain timeframe. This favours some measures over others (e.g. it is much easier for a public administration to spend 100 million dollars in building roads than in supporting start-ups). Developing systematically new approaches is a long-term process and requires institutional capacity, both on behalf of funders (being able to administer a large number of small-scale projects) and on behalf of recipients (being able to develop high-quality projects). Institutional support and funding schemes that are available for a number of years can help to support more transformative innovation systems (see also [page 31](#)).
- **Short-term concerns vs. long-term vision:** there is the risk that even though a long-term vision exists, short-term concerns will significantly influence the selection of activities. Thus, it is important to critically assess whether quick-win actions are really future-proof and in line with long-term objectives.
- In particular, **further support for unsustainable practices** could lead to unintended dependencies and lock-in effects, which hampers regions' ability to achieve the objective of climate neutrality and leads to stranded assets.

- **Lack of synergies:** existing structures (sectors and administrative responsibilities) often hinder the harvesting of synergies. For example, while it is obvious that actions in the energy sector need to comply with climate targets, climate proofing or climate mainstreaming in other areas such as business development is a new issue that has yet to be implemented.

Keys to selecting actions

Given the diversity of coal regions, there is no one-size-fits-all answer when it comes to how to deal with these challenges. However, the process of selecting actions is key, including:

- **Transparency:** the minimum requirement is that the selection process (including selection criteria and selected actions) is made transparent, so the public has the opportunity to assess whether and how the actions relate to the overall development objectives.
- **Engaging a broad range of stakeholders** in the selection process is crucial for Just Transitions to ensure that a multitude of objectives are met. However, this requires professional facilitation to balance power and knowledge differences among the different actors and interests (see "[Designing effective governance models](#)" on page 40).
- **Formalised procedures** can help to facilitate selection processes.
- **Multi-criteria analysis** (see [page 32](#)) is an approach which helps to align potentially conflicting objectives and is suitable for reducing power differences.

Selecting transformative projects

Transformative change converts a current system or current systems (ecological, social, political, economic, scientific or technological) into a fundamentally new one that, from there on, forms the new mainstream.

The transition process towards a zero-carbon society is nothing less than a fundamental transformation of our society. It is not only a technological issue (substituting fossil energy with zero-carbon technologies) but also ushers in changes in all dimensions. New business models and new companies will emerge, consumer practices will change as well as social behaviour and cultural habits, and new legislation and institutions will be created. In many cases, we need and will encounter fundamental paradigm shifts. The challenge in selecting projects to support this transformation is that no single, individual action or project will bring about the full transformation. The question is then, how can we choose and design projects that, together, pave the way to the necessary transformation?

TransformAbilities - design principles for transformative change

Following a holistic vision of a transformation towards a zero-carbon society, GIZ developed design principles that should help practitioners identify options that are as transformative as possible under the current systemic conditions. The guidebook '[Transforming our work: Getting ready for transformational projects](#)' features the TransformAbilities framework that can provide indicators to successfully facilitate change.

Each project or action needs to support the following 'obligatory' key elements:

- *ParadigmshiftAbility*: do the actions support the necessary fundamental paradigm shift?
- *ScalAbility*: is the action scalable? And, if scaled, would it be in line with transformation targets?
- *SustainAbility and ResilienceAbility*: is the action fit to weaken the resilience of the existing (unsustainable) system? Does it facilitate the stability of the new, desired system?

The guidebook provides tools, background information and concrete check-lists to assess potential projects.

FIGURE 10
Design principles for transformative change

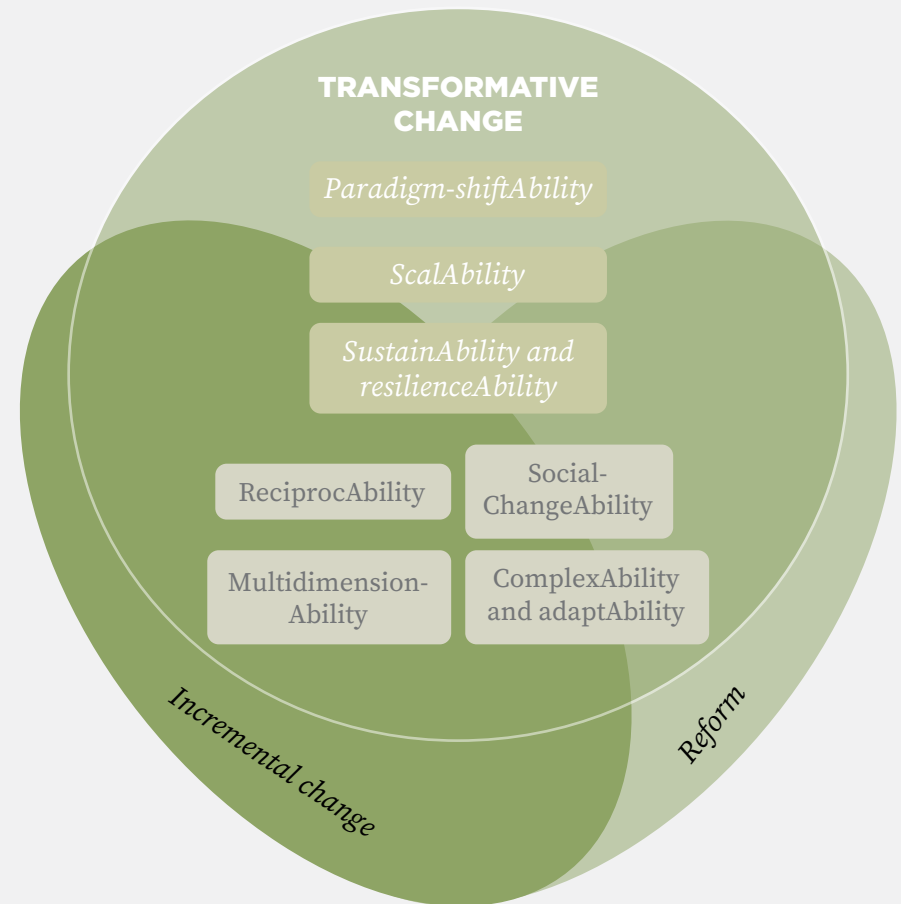

The learning

Monitoring, reporting, evaluation and policy adaptation

Monitoring and evaluation is often a forgotten pillar in strategy development. However, the end of one policy cycle actually marks a new beginning: entering into the next cycle and adapting the strategy based on what was learned in the first round. In practice, regions normally undergo a continuous process. Even after the first or second year into a new strategy, adaptation will be required based on experiences and learning.

Some changes are immediately necessary due to changes in the framework (e.g. new government and policy priorities at the national level, new funding options, changes in markets, etc.). Others stem from very obvious learning (e.g., a certain approach did not work the way it was expected). But order to make a strategy truly effective it is important to take a closer look at what worked and what did not. A proper monitoring and evaluation system needs to be set up to this end.

Even though we describe monitoring and evaluation occurring at the end of the policy cycle, it needs to be considered and implemented from the very beginning.

Monitoring and evaluation systems should include both quantitative and qualitative indicators

Quantitative indicators (e.g. CO₂ emissions, money spent, workshop participants) are a key element of any monitoring and evaluation system. They are easy to depict or demonstrate (e.g. in graphs) and allow comparisons (e.g. across regions or across time). However, qualitative indicators and assessments are equally important. There is a risk that focusing on quantitative indicators could lead to a focus on what is 'measurable' instead of what is important.

For example, it is easy to measure how much money was spent, but this does not tell us whether it was spent wisely. It is easy to measure how many people participated in a workshop. But were they actively engaged? Did they feel that what they said really mattered?

Moreover, it is possible to estimate the impact of a whole policy package, whereas it is often impossible to measure the impact of individual elements. For example, the development of CO₂ emissions in the housing sector can be monitored and it is fair to assume that efficiency gains through enhanced retrofitting will certainly help to reduce emissions. A support scheme for this may include financial support, information campaigns and training for local workers. However, the question 'How many tonnes were saved due to the information campaign?' is impossible to answer. A solution might consist of a mix of quantitatively assessing some elements (e.g. overall CO₂ emissions and job creation contribution) and qualitatively assessing others (e.g. with interview questions like: 'How should information campaigns for homeowners and training support for workers be improved to make them more effective?').



Topics of monitoring and evaluation processes must reflect the various objectives of the strategy

While it might sound trivial, there is a risk that monitoring and system evaluations could focus on only a subset of topics – often those that are easy to measure or those that are the priority of the implementing agency. For Just Transition processes in coal regions, a balanced mix of economic, environmental and social assessment criteria would be key.

Stringent monitoring and evaluation

Stringent monitoring and evaluation are very helpful for future decision-making but involves quite a lot of effort. Evidence-based monitoring, evaluation and policy learning can be supported with accompanying research (and if it is conducted by a regional research institute, more local knowledge on transitions is created). Elements of the process can be outsourced to consultants. But in any case, regional authorities do need some institutional capacities of their own to ensure that the results of monitoring and evaluation processes can be incorporated in the strategy's revision.

Irrespective of who is responsible, a proper budget must be set aside for monitoring and evaluation. This needs to be considered as part of the strategy from the beginning.

In a complete monitoring and evaluation system, all four levels are addressed. However, there is a methodological difficulty: it is very difficult to reliably link outcomes and especially impacts to specific actions. As a result, it is important to provide estimates for all of the above levels with respect to specific actions undertaken (e.g. how many new jobs in a new factory). This needs to be complemented by high-level data such as job development in all sectors across the region.

Monitoring and evaluation should be addressed on various levels:



Input

which resources have been mobilised? (e.g. how much money was spent?);



Output

what has been done? (e.g. number of workshops held);



Outcome

what has been achieved? (e.g. level of knowledge on an issue has increased);



Impact

how has this contributed to the overall goal? (e.g. development of CO₂ emissions).

Optimisation: strategy and policy adaptation

A good process needs to be set up that allows for learning and improving the strategy. The institutionalisation of an adaptive policy cycle depends on the specific governance structures in the respective region to a significant extent. But despite the differences, the following elements can be helpful for all regions:

- **Plan in cycles:** the strategy's revision should be an element that is planned right from the beginning.
- **Transparency and public debate:** making the results of monitoring and evaluation activities public can help to increase the sense of ownership and commitment among the stakeholders involved and the public in general. Moreover, this can prompt implementing agencies to rethink and possibly improve their activities. Publishing monitoring and evaluation activities obviously takes some effort and is politically sensitive (especially when results are not entirely positive in the beginning) but has the potential to create very positive long-term effects.
- **Ownership and leadership:** key decision-makers must openly promote monitoring and evaluation results and commit to an adaptive learning process.

EXAMPLE & TOOL

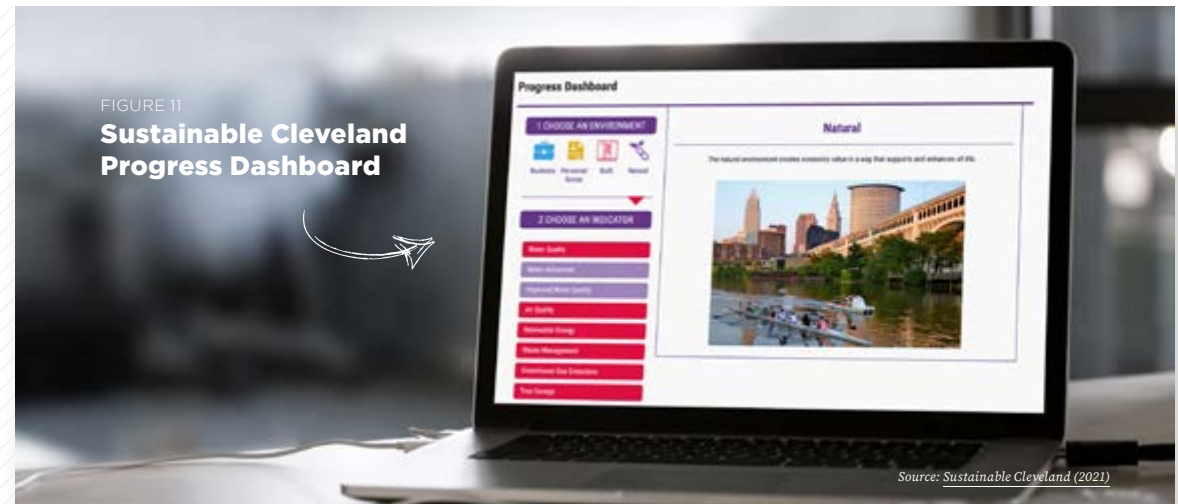

Monitoring and evaluation

Sustainable Cleveland Dashboard

In Cleveland, USA, the city developed the interactive ‘Sustainable Cleveland Progress Dashboard’, an online resource to track regional progress toward business, personal/social, built and natural well-being. The dashboard provides a set of indicators for each of the four categories and displays a chart on progress that has been achieved. Examples of indicators include green jobs, cost of living, healthy local food, bicycle infrastructure, air quality and renewable energy. The Progress Dashboard serves as a continuous monitoring system that makes the region’s development both transparent and easily accessible.

→ [Read more](#)

Monitoring the transition to a low-carbon economy: A strategic approach to local development

This working paper is an outcome of an OECD Local Economic and Employment Development (LEED) project that investigated key indicators relating to an area-based transition to a low-carbon economy. The objective of the project was to provide defined measurable indicators at the regional/local level that could provide local governments and other institutions with information in the form of monitoring guidelines centred on the development of a local green growth indicator framework.

→ [Read more](#)

Further resources

European Commission: ONLINE-S3. Toolbox on smart specialisation

The EU research and innovation strategy for Smart Specialisation (RIS3) is a relatively new policy concept developed by the European Union. In brief, smart specialisation is about identifying a region's key activities, areas or technological domains that give them a competitive advantage, and, as a result, to focus transformative efforts on those activities.

While mainly developed as an e-policy platform for EU national and regional authorities, the online-S3 platform can be also a helpful tool for non-EU coal regions, especially the guidebook for smart specialisation processes as well as a toolkit, covering 28 tools among six phases: (1) identifying the process stakeholders and forming the process organisation; (2) analysis of context, (3) strategy formulation, (4) priority setting, (5) defining a policy mix, and (6) monitoring and evaluation.

[-> Read more](#)

EIT Climate KIC: Design sprint

The Design Sprint is an approach to create an innovative concept within a short time. The concept has received a lot of recognition over the last couple of years in the business world, but can be used in all kinds of contexts. In the form of a workshop, the design sprint makes use of a variety of design thinking methods to create truly innovative solutions to challenges or problems of the status quo. Instead of ending with a vague idea, the design sprint ends with a well-advanced prototype serving as a roadmap for implementation.

[-> Read more](#)

EIT Climate-KIC (2016): Visual Toolbox

The resource book for practitioners to map, analyse and facilitate sustainability transitions offers a wealth of creative methods to support system thinking and transition processes. Methods support among others: mapping of challenges and options, facilitation of stakeholder engagement, visioning, and backcasting.

[-> Read more](#)

Dodgson et al. (2009): Multi-criteria analysis: a manual

This extensive manual provides practical guidance for Government officials and other practitioners on how to undertake and make the best use of multi-criteria analysis (MCA) for the appraisal of options for policy and other decisions, including but not limited to those having implications for the environment. It covers a range of techniques, which can be of practical value to public decision makers and was designed to help non-specialist staff to gain a broad understanding of the advantages offered by MCA. It focuses on techniques that do not necessarily rely on monetary valuations, carried out in a non-technical language.

Chapters 2–4 of the manual provide a broad overview of the techniques for non-specialists, while Chapters 5–7 provide more detailed guidance, including how to set out the stages involved in carrying out a multi-criteria analysis, how to wrap up a scoring system and highlight examples by presenting case studies.

[-> Read more](#)

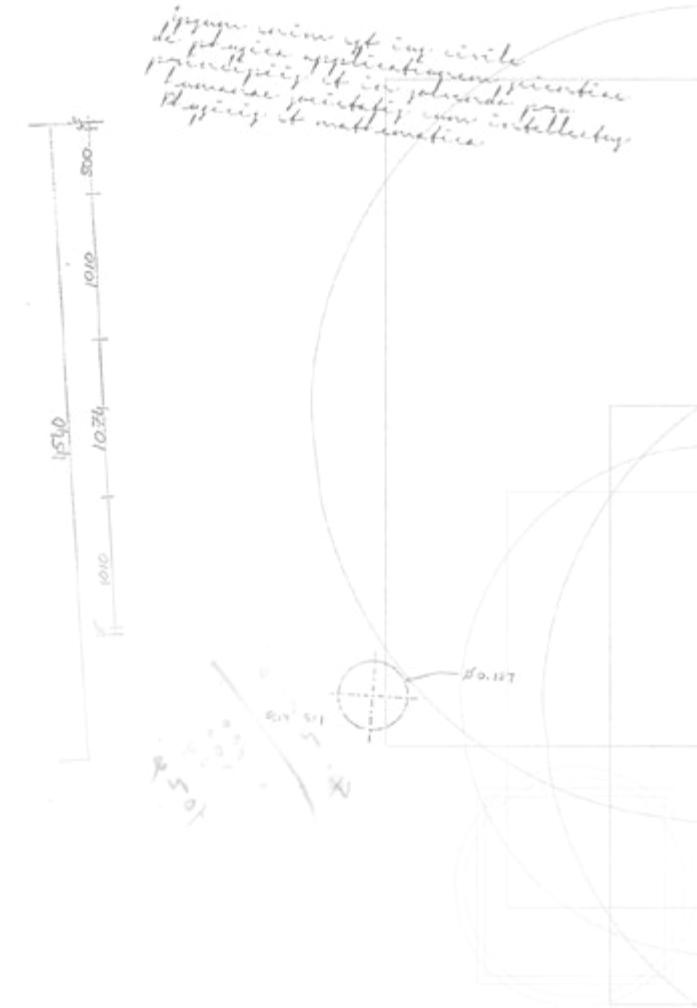

World Bank (2004): Ten Steps to a Results-Based M&E System

The Ten Steps to a Results-Based M&E System course is aimed at policy and decision-makers who need help to organise thinking around strategy and planning while recognizing the need to measure and monitor the success of what is planned. This handbook provides a comprehensive ten-step model that will help guide development practitioners through the process of designing and building a results-based monitoring and evaluation system. These steps begin with a 'readiness assessment' and take the practitioner through the design, management, and importantly, the sustainability of such systems. The handbook describes each step in detail, the tasks needed to complete each one, and the tools available to help along the way.

This handbook can be accomplished by the very extensive "Making Monitoring and Evaluation Systems Work: A Capacity Development Toolkit" which is designed for technicians and development practitioners to actually develop a functioning monitoring and evaluation system.

→ **Handbook**

→ **Toolkit**

International Institute for Sustainable Development (2018): Real People, Real Change: Strategies for just energy transitions

The purpose of the report is to provide governments from the Global North and Global South with key recommendations on how to address just energy transition. It highlights political and communication strategies used in the process and is based on past and current research and case studies done in Canada, Egypt, Indonesia, India, Poland, and Ukraine.

→ **Read more**

Germanwatch/EcoAction/GIZ and German Ministry of Economic Cooperation and Development (2020): Transformation Experiences of Coal Regions: Recommendations for Ukraine and other European countries

This study provides an overview of the main takeaways from the analysis of the four European countries Germany, Czechia, Romania and Ukraine and lays out a set of recommendations essential for a just energy transition from coal combustion toward sustainable economic development.

→ **Read more**

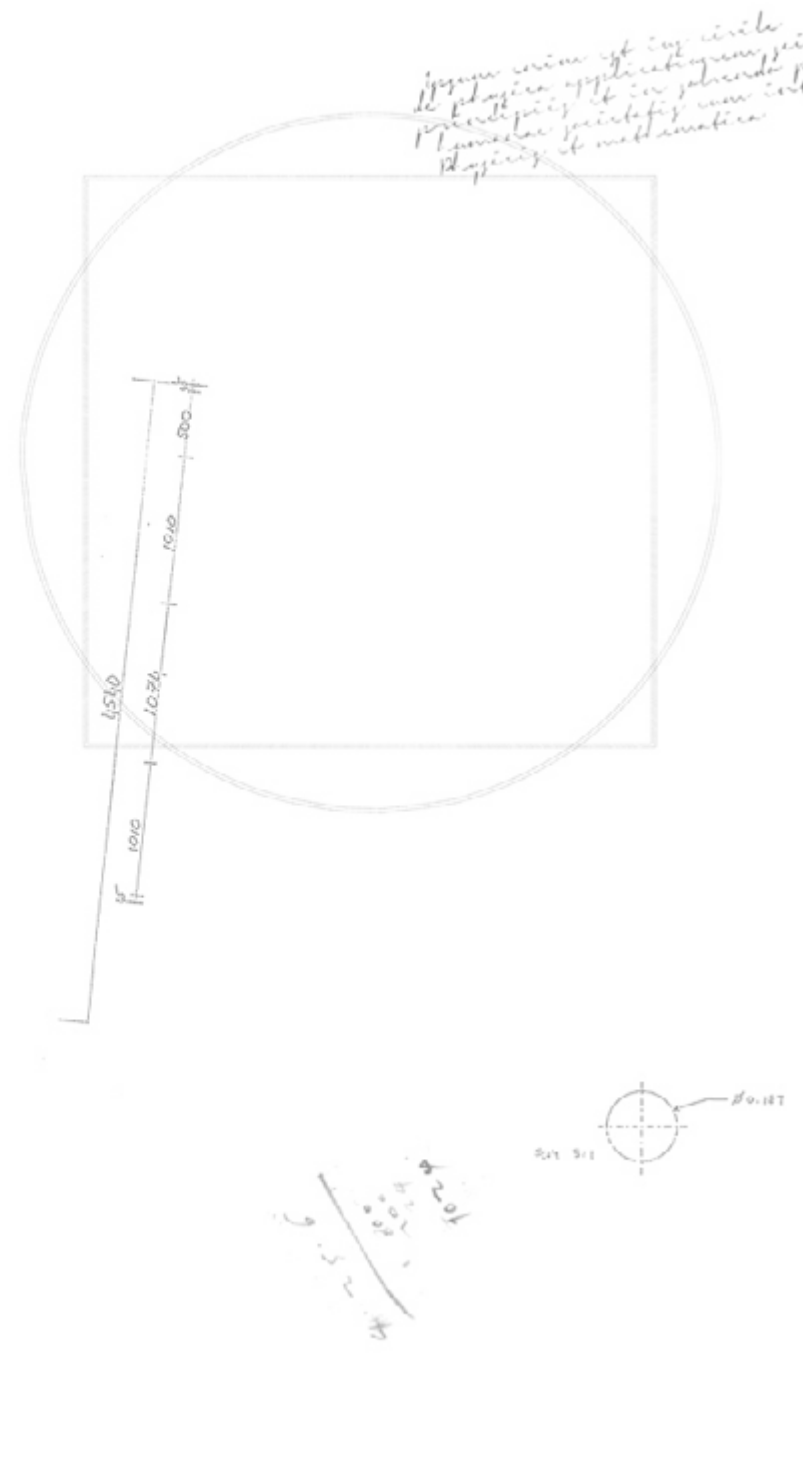

*Ipsum enim est in civitate
de physica applicationem scientiae
principium et in solvendo pro
universae societatis non intellectus
logicae et mathematicae*

$$\frac{1}{2} \pi r^2$$
$$E(h) = \frac{r}{2}$$



*Facit enim ingenium primario
partis investigandi etiam non primario
universae societatis non intellectus
logicae et mathematicae*

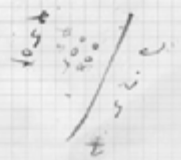

2

Designing effective

governance models

Designing effective governance models overview

The purpose of this section is to provide insights into key governance aspects for regions that are pursuing the decarbonisation and diversification of their economies.

DESIGNING THE GOVERNANCE MODEL

Key elements of effective governance and a step-by-step approach to build the right governance model

[-> Go to section](#)

COOPERATION LEVELS AND RELEVANT ACTORS

An overview to the elements of multi-level and multi-actor governance processes.

[-> Go to section](#)

STAKEHOLDER ENGAGEMENT OF AND PARTNERSHIP BUILDING

Benefits and common barriers of stakeholder engagement, including tools and examples.

[-> Go to section](#)

SOCIAL DIALOGUE

The special role of unions and civil society in the transition governance process.

[-> Go to section](#)

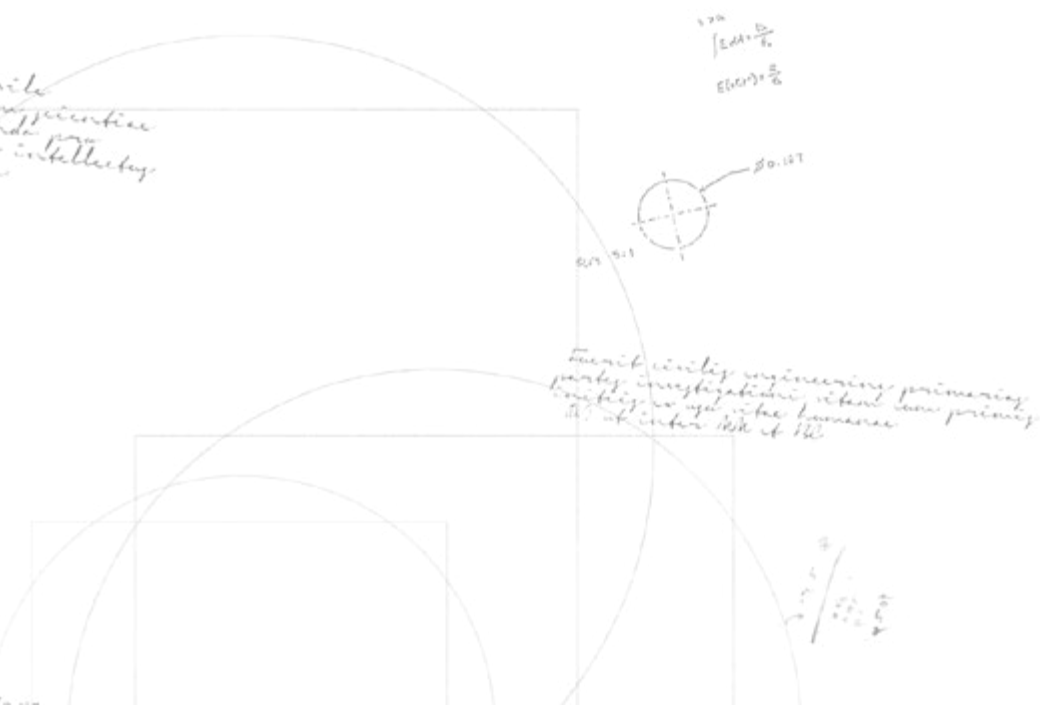

Introduction

The governance of regional transitions away from coal mining and coal-based energy generation is a complex process that requires effort from multiple actors. In many cases, coal regions do not align with a particular set of administrative boundaries and therefore require collaboration across different administrative units and levels of government. Identifying solutions to effectively manage and coordinate the efforts of multiple actors across different levels of governance is, in turn, a complex challenge. However, guiding principles and practical examples are available to support coal regions in approaching the formation or enhancement of appropriate governance structures in such contexts.

Moreover, a participatory and inclusive process fosters and ensures ownership and strengthens the legitimacy of the transition. Tools and experiences are readily available to support regions in engaging with all those affected, taking their views into consideration in decision-making processes.

Social dialogue lies at the heart of the Just Transition and is either a bipartite process between unions and employers or a tripartite process that includes governments. It is a key process to anticipate changes in the workforce and deliver key agreements. There are a number of examples that demonstrate its role in regional transition processes.

Lastly, the involvement of civil society in transition governance is vital. This element is often overlooked and cited by regions as a particular challenge for which further examples and guidance are needed.

The purpose of this section is to provide insights into elements of key governance aspects in regions that are pursuing the decarbonisation and diversification of their economies. These include building effective governance models; designing and implementing stakeholder engagement and social dialogue processes; and enhancing the role of civil society in the transition.

IN BRIEF

What is governance?

The concept of governance refers to the various ways in which different actors and factors work together in the pursuit of a collective goal and the formal and informal means by which they can be influenced. A wide range of actors and stakeholders is involved in coal regions in transition (institutions, civil society, employers, workers, etc.), and they can interact in multiple ways.

What is a governance model?

For the purposes of this toolkit, we define a governance model as the arrangement put in place by a national or regional authority to deliver its coal transition strategy in a way that is effective within the broader governance context prevailing in the region. Governance contexts are heterogeneous and range from strong local self-government to more centralised systems.

What are actors and stakeholders?

In short, the term actors refers to all those that play a role in the transition and have some form of power in relation to the decisions at hand, while the term stakeholders refers to those positively or negatively affected by the transition. The two may overlap considerably in the context of transition governance (i.e. a particular organisation may be both affected by the transition process and be in a position to influence decisions).

Designing the governance model

Key elements of effective governance in the context of coal regions

Some key aspects to consider when designing an effective governance model in the context of coal regions in transition include:

Leadership

Regardless of the prevailing governance context (centralised vs. decentralised; private vs. state-owned coal sector), legitimate political leadership is indispensable to lead change, lay out decision-making processes and clarify roles and responsibilities across a diverse set of agencies at the national, regional and local levels ([Read more](#) on Managing Coal Mine Closure)

Increasingly, leadership in transitions is a shared effort. As well as political leadership, the role of key institutions and individuals who proactively manage the transition process within their institutions or projects is also vital for success. Influential non-institutional stakeholders can also provide leadership (e.g. trade unions, NGOs, citizen groups, or business associations). For example, [distributed leadership](#) is increasingly seen in urban transitions and can deliver much-needed integrated change.

Depending on the context, each country and region will have a different definition of what 'good leadership' constitutes. Finally, it is important that transition strategies are able to withstand changes in leadership.

Power and influence

Decisions regarding governance arrangements cut to the heart of power and legitimacy and, as such, must be adequately understood. Power takes many forms and can be exercised by a range of different actors. Understanding the power and influence of actors who do not support, or who actively oppose the transition ('vested interests') is of particular importance.

Different levels of governance will have different power and influence structures. Often, regional and local authorities in coal regions find that they do not have the authority to address some of the necessary aspects of their transition. This applies, for example, to the allocation of financial resources, design of curricula and (re-)training programmes, ownership of mining sites, etc.

Institutional capacity

To function properly, governance needs to have the capability as an institution to set and achieve its goals through a combination of knowledge, time and resources by people within the administrative system. This is described as 'institutional capacity' – the actual ability to fulfil certain tasks in a governance system. Especially at the regional and local level, experiences in the past have shown that government institutions often lack the capacities to fulfil their additional tasks that stem from the transition challenge – due to insufficient time, knowledge or financial resources, or all of the above. This makes capacity building on all governance levels crucial for the actual implementation

of the transition. Regions can seek support e.g. through international organisations that offer capacity building programmes, such as the [Initiative for coal regions in the EU](#), development banks (especially the World Bank's [ESMAP](#) initiative for coal regions), philanthropic organisations as well as some NGOs.

Transition strategy

The governance model chosen for a transition needs to be closely interlinked with the policy cycle (see ["The policy cycle" on page 22](#)). Different stages of the cycle will call for different governance approaches and for different actors to be involved in the process. For example, a broad range of actors will need to be involved in the strategy formulation stage, and implementation will require that roles and responsibilities are clearly assigned to ensure delivery – but done in such a way that also allows scope for experimentation and innovation. The drivers of the strategy (political and economic factors) will also influence the governance model.

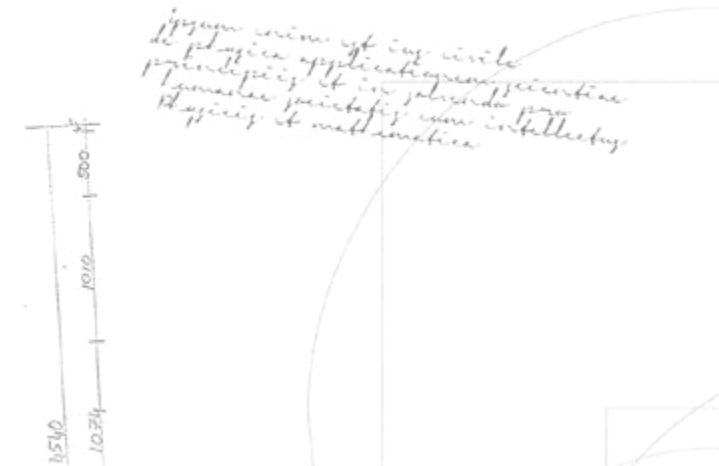

Step-by-step guide for building the right governance model

A governance model or governance arrangement cannot be 'right', per se – not least because there is no established framework to evaluate this. What is most important and what makes it 'right' is whether it is right for a given region. Some key steps in designing the right governance model are listed below.

Understand the existing governance structure

Transition governance structures need to work within and alongside existing structures. This step consists of understanding both institutional roles and the power structures in the context of the overall transition vision and goals, as well as identifying the key actors and what their roles are in the decisions needed to implement the strategy. Building a governance model that harnesses the existing powers available to the regional authority can be challenging. The powers of local and regional actors are strongly dependent on, and specific to, the multi-level governance structure to which they belong (see [page 48](#)). It is also vital to identify vested interests and make a plan for how to address power imbalances.

Tools and templates are available to help governments and key stakeholders get a snapshot of their existing governance structures, accountability mechanisms and political power balances as well as to produce maps of predictable future imbalances. Many tools apply to particular sectors such as health or water (other examples are available in this compendium and can be adapted to the context of coal regions in transition).

Example: The NGOs Bankwatch and Greenpeace worked closely with government actors operating

IN BRIEF

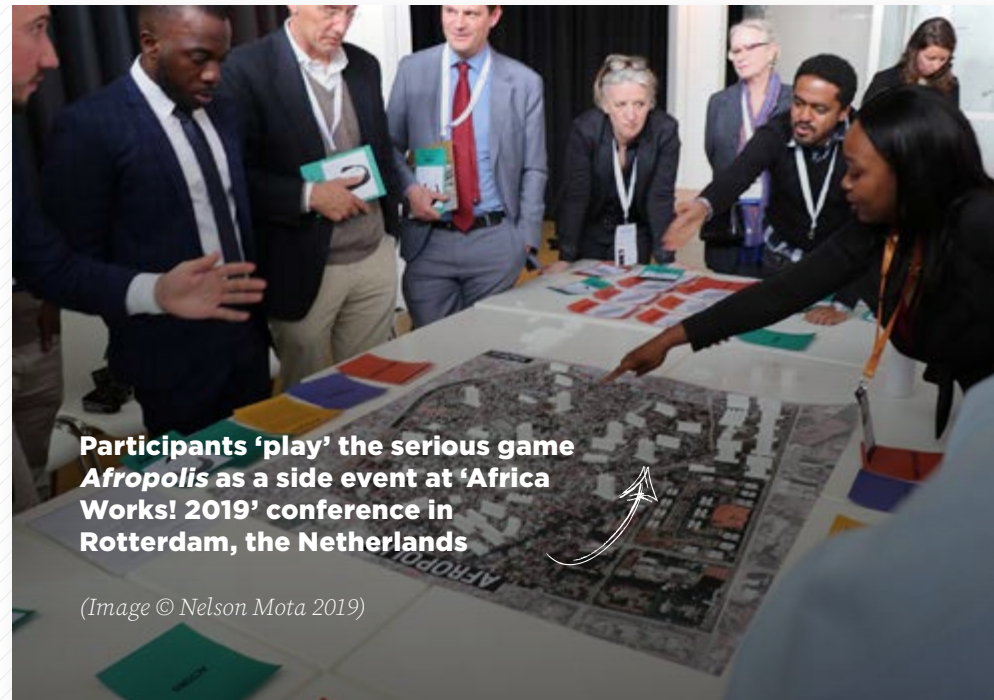

Participants 'play' the serious game *Afropolis* as a side event at 'Africa Works! 2019' conference in Rotterdam, the Netherlands

(Image © Nelson Mota 2019)

What is good governance?

Good governance can mean different things in different contexts but always revolves around these core principles:

- Transparency
- Participation
- Rule of law
- Equity and inclusiveness
- Effectiveness and efficiency
- Accountability

→ **Read more:** [Good governance: a framework for successful government.](#)

between and across different geographic scales in the [Jiu Valley \(Romania\)](#) to foster an understanding of where the power and responsibilities to manage the region's transition were located and to identify related interdependencies. A forum was convened to explore the roles and responsibilities of various national and subnational actors in the transition process, including different ministries operating at the national level. This analysis was not only required to shed light on the relationships between and across levels of governance but also to promote an awareness of the need for coordination and cooperation. The two NGOs were also instrumental in creating an agreement for a partnership between the six localities in the Jiu Valley.

Legitimise and make transparent

Transition strategies are more likely to be effective when those affected by the transition view these strategies as legitimate, with a transparent mandate and purpose. For this reason, a participatory approach is a prerequisite to implementing speedy and socially just regional transitions. Ensuring a broad variety of legitimate stakeholders is represented within the governance model is one part of this. Transparency regarding the composition of the governance model, its purpose, the guiding principles of how it will work and the impact it can and cannot have will also increase acceptance.

Example: The governance structure of the [RE:START](#) initiative, put in place by the Czech government, is an example of how initiators of the transition communicated the distribution of competencies and responsibilities to the wider public. It also serves as an example of how a governance model evolved with the transition strategy (see box on [page 26](#)).

Allocate responsibilities for key decisions

The complexity of governance systems and the interdependence of issues can hinder the assignment of clear responsibilities, and some regions may find that it is ultimately difficult to hold anyone accountable ('the problem of many hands'). Those overseeing the setup of the governance framework for transition should assign clear roles to different stakeholders as part of the codification of the governance model. They should clearly delineate who is accountable based on their potential for leveraging action at different stages and in different domains of the strategy. Even when the governance model is established in a top-down manner, leadership can benefit from assigning responsibilities to locally-engaged, intermediary agents and partnerships so as to ensure local insights are gathered and locals are represented.

Example: [Latrobe Valley Authority \(LVA\)](#) in the state of Victoria, Australia, is an example of an intermediary agency that was established by the state government and assigned to lead the transition process for the region. The agency addresses both mine closure and economic diversification in the region's transition strategy. Its mandate includes building partnerships with industry, higher education, local government and community organisations. The allocation of appropriate budget and human resources is essential, but the most crucial aspect is the degree of autonomy granted by the state government to the agency. This enables it to set priorities and allocate funds more efficiently and to effectively implement decisions.



Transition strategies are more likely to be effective when those affected by the transition view these strategies as legitimate, with a transparent mandate and purpose

Identify levers of influence and windows of opportunity

Depending on the prevailing governance context, regional and local governance actors will have different levers available to them to influence the decision-making of other actors. These include:

- Legislation and regulation
- Financial support
- Fiscal measures
- Spatial planning
- Asset management
- Public procurement
- Awareness raising
- Capacity building

Example: The World Bank-financed [coal transition programme in Western Macedonia \(Greece\)](#) highlighted two windows of opportunity that were targeted by the programme. The first was a review of environmental regulations scheduled for 2021 that would allow a widening of the scope of mine repurposing interventions, and the second a scheduled update of the existing regional spatial plan. The latter window provided an opportunity to influence and link land repurposing to the regional spatial planning process.

Reflect and adjust

The governance model can, and will likely need to, evolve over time. Its design should reflect the point in time at which different actors need to be engaged, how and on what topics, as well as when roles will need to change. Often, regional and local governance actors – particularly those working in very centralised governance contexts – may first need to develop their capacity in order to be actively involved. The development of a common vision for the transition strategy should consider at what stage certain actors are going to be involved in decision-making and how.

TOOL



Policy levers for local governance

In the context of urban transitions, the paper '[Urban policy levers for circular economy transitions](#)' published by the Ellen MacArthur Foundation identifies over 100 examples from more than 70 cities around the world of the various policy levers city governments can use to promote circular economy transitions, many of which apply in the context of energy and economic diversification.

Just as different levers can influence decisions in a governance model, there are also varying windows of opportunity for regional and local actors to leverage their power or to influence other actors to make necessary decisions.

Cooperation levels and actors

Multi-level and multi-actor governance

The transition of coal regions is a multi-level and multi-actor governance process. But how can the interactions between different levels and actors be best harnessed? How can the scope for interaction be enlarged?

The 'vertical' levels of government, as defined by territory, jurisdiction or mandate are widely understood. There are, however, other dimensions of interaction that can involve different economic sectors, workers and employers, various parts of civil society (e.g. faith-based organisations, environmental NGOs, etc.) and other key actors representing media, culture or academia. The multi-level nature of governance models for coal regions in transition will need to harness existing interactions among levels and actors as well as acknowledge that boundaries between levels and competences can sometimes be 'fuzzy'.



FIGURE 12
Multi-level governance

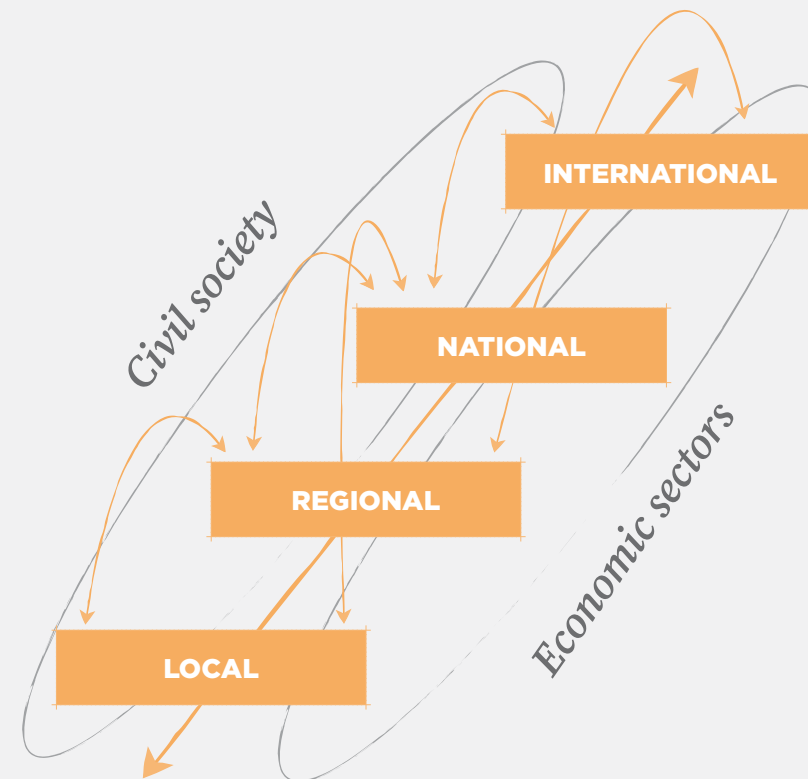

Key actors

Multi-stakeholder consultation and community engagement requires knowledge about who are the actors and stakeholders to be involved. The following groups of actors should be considered first and foremost for regional governance processes:

- **Individual companies:** new and existing employers in a variety of sectors should be engaged as they will be key e.g. in terms of offering employment and/or training. Employers in green energy sectors are particularly important stakeholders.
- **Central government:** central governments might be able to negotiate agreements with large coal companies and influence outcomes at local levels.
- **Sub-national authorities:** local governments have a good overview of the region and its context and can serve as a link between various actors.
- **Social partners (trade unions and employer representatives):** trade unions have a key role to play in supporting and advising workers, both collectively and individually. They are key actors in terms of working with employees to help devise training and outplacement. Trade unions can also represent workers' interests and provide pragmatic approaches to guarantee working conditions, thus helping to ensure a Just Transition. Trade unions and employer representatives also have a specific role in relation to collective bargaining and social dialogue.
- **Community representatives:** transitions have a significant impact on the local area, so it is important that representatives of the community are engaged in addition to those representing local authorities.

GOOD PRACTICE



© Copyright M J Roscoe (CC BY-SA 2.0)

Cooperation between actors

The Oakdale Colliery wind project is located in the former Oakdale Colliery coal mine, which covers around 162 hectares in Wales, UK. It has a capacity of 4 MW (2 Senvion MM100 wind turbines of 2 MW rated power each) and will generate approximately 10 GWh/year. This project was developed via a public/private partnership between the organisation Partnerships for Renewables and the Caerphilly County Borough Council. It will provide job creation and additional revenues to the local community. Partnerships for Renewables will pay rent to the council for use of the area as well as a community benefit package of about USD 12,000 per year throughout the lifetime of the project, which will be invested in projects that create social, economic or environmental benefit.

- **Most vulnerable groups and communities:** the perspectives of social groups and communities that are most vulnerable to climate change, coal mining and/or coal phase-out need to be incorporated into governance processes for a Just Transition. These groups can vary depending on region. In general, they are marginalised groups with little access to resources, such as women, indigenous people, members of lower socioeconomic classes or children and youth as well as informal workers and coal gatherer and sellers.
- **Public employment services:** public employment services at the regional and local levels can play a vital role in helping to match the supply of and demand for employment. They can also coordinate training needs and opportunities.
- **Funding bodies:** all levels of funding are relevant, from international, to national, to local and regional sources of funds. Funding can come from both public and private sources or a mixture of the two.

IN BRIEF

Make sure women and other marginalised groups can participate

‘Given the urgency of the climate crisis, we can’t afford to lose the expertise of about half the population on how to best solve it.’

Mohr et al. 2020, p. 20

(Coal) transition processes in all parts of the world are still often characterised by a lack of women in formal decision-making bodies. There are different barriers that prevent women from participating in a meaningful way: in many communities women are still expected to be the family caregiver and to stay at home, while the men take care of public business. This means that in many cases, women are not asked or not even allowed to formally participate in governance processes. Some studies also show that it is often more difficult for women to gain access to institutions like trade unions and government bodies. As a result, women tend to instead get involved in less institutionalised ways such as self-organised grassroots movements and community work, while men take over formal leadership in unions or local government. In addition to this, women have less financial resources on average and (due to care work) less time available. This also makes it more difficult for them to promote their interests and perspectives.

Measures to effectively include women in governance processes of regional energy transitions include for example:

- Introducing gender parity in decision-making bodies and consultation bodies (like expert groups)
- Ensuring that local women initiatives and grassroots organisation are included in governance processes
- Acknowledging and giving visibility to the agency, activism and contribution of women and other marginalised groups to a Just Transition
- Providing access to care services to all women and fostering a fair distribution of care work as preconditions for political and social participation of women
- Developing strategies to overcome traditional gender roles.

Overall, it is important to note that women are not a homogenous group and that other factors such as race, class and (dis)ability also determine people’s agency and ability to shape (transition) processes. The needs, viewpoints and priorities of marginalised groups should be incorporated in transition policies in keeping with the basic idea of Just Transitions. To this end, structural barriers that prevent marginalised groups from political and social participation must be examined and dismantled. Most importantly, it is vital to ensure that everybody is given the same access to debate and that everybody can speak as equals.

For more information, see [Strengthening Gender Justice in a Just Transition: A Research Agenda](#), a panel discussion on the [gender dimension of Just Transition](#), [Gender-responsive climate policy: A case study of the Colombian coal sector](#) and [Recommendations of the Global Commission on People-Centred Clean Energy Transitions](#).

Stakeholder engagement and partnership building

In order to be effective, the regional transition governance model must sufficiently reflect the views of different regional actors, and the representatives of these actors should be recognised as legitimate. Most countries and many regional authorities in coal regions in transition already conduct stakeholder engagement processes to some degree. However, these differ substantially in terms of their scope, transparency and degree of involvement. Stakeholder engagement that starts early, is systematic, is sustained over time, and gives a meaningful degree of involvement to stakeholders is crucial to the success of transition strategies in coal regions.

The following pages provide guidance and examples of stakeholder engagement processes and tools.

Why should we engage stakeholders and build partnerships?

Benefits of engaging stakeholders:

- Builds trust and legitimacy
- Increases the impact and pace of progress, i.e. saves resources in the long-term
- Enhances understanding of resistance and opposition and can help overcome these
- Decreases uncertainty and strengthens risk management
- Informs and raises awareness and acceptance among stakeholders
- Can spur needed innovations;
- Broadens the knowledge base of decision-makers and participants

Risks of not engaging stakeholders:

- Increases uncertainty or non-acceptance of outcome
- Can lead to a lack of trust and inefficient use of resources
- Can lead to factions and divisions
- Sustains silo mentality
- Can have ethics and compliance implications.

Engaging and consulting all relevant stakeholders as early as possible is of particular importance. This is no easy task, as tailored workforce transition programmes and, most importantly, building up local economic resilience will require time, preparation and learning by doing.

Steps in this process could include:

- **Identifying relevant stakeholders.** Research to find out who the key actors are in the region.
- **Mobilising stakeholders.**
- **Establishing contact with key actors.**
- **In-depth or focus interviews:** Establish communication with key actors to identify the areas in which they can contribute.
- **Workshops or meetings:** Develop a plan based on a common vision and policy mix, and develop key roles and tasks for the stakeholders, timeline and monitoring indicators.

One example of cooperation among local governments and with civil society organisations is that of the Platform on Sustainable Development of the coal mining towns of the Donetsk region in Ukraine. The



What is stakeholder engagement?

Process by which an organisation leading the transition in a coal region engages with and involves those who are affected by the decisions that are made. Stakeholder engagement goes hand-in-hand with partnership building, both of which allow stakeholders to pool their resources to solve common problems.

Platform is composed of six town administrations, three local civil society organisations and the regional chamber of commerce and industry. The platform signed a [memorandum of understanding](#) in May 2019 that has the potential to contribute to a successful transition of the Donetsk region and to give the transition increased credibility and visibility at the regional and national levels.

Another example of an approach to harness multiple levels of governance together with stakeholders and communities has been developed by the [Zukunftsagentur Rheinisches Revier \(ZRR\)](#) agency in Germany, which is a joint effort between municipalities, business associations and trade unions from the mining, chemicals and energy sectors who came together and became shareholders in a new regional development agency. Since 2014, the ZRR has been active in developing a shared vision and a development strategy for the region. It has organised idea contests and networking events and conducted studies on the prospects of specific industrial sectors in the region, which also provides an example of how regional diversification strategies can be governed in practice (read more about the ZRR on [page 130](#)).

Are you informing or are you involving?

The process of stakeholder engagement calls for different levels of participation depending on the issue at stake (see figure 13). A fine balance must be maintained regarding who will be involved in which stage, and there is a need to be transparent about what level of participation is foreseen at each stage. For example, it is important not to claim that stakeholders are going to be involved in a decision when only a transparency hearing is foreseen.

During the first stages of the development of the transition strategy (development of common vision and goals) a strong degree of engagement with a broad base of actors may be advisable. Decisions at other stages of the implementation process will, conversely, call for the involvement of smaller groups, while interested parties should nonetheless be kept informed of developments.

Finding the right balance between information and involvement requires planning which decisions need to be made at each stage and who needs to be at the table for each one. The process of stakeholder engagement must always include an active communication strategy that informs the general public about the process, how they can take part and what will happen next. A variety of formats should be used to ensure all groups can be reached.

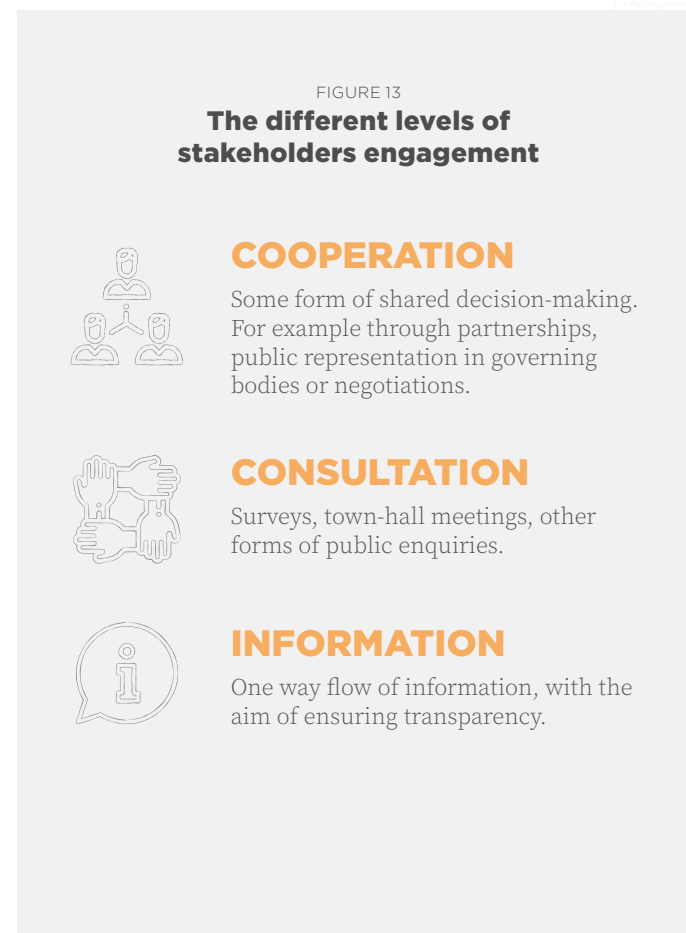

Guidance

An example of guidance available in the context of coal regions in transition are the [‘Seven Golden Rules for open and inclusive Just Transition planning at the regional level’](#). This publication consists of a series of principles to guide regional and national authorities in developing and implementing Just Transition strategies at the regional level (more details on the Just Transition concept are found in the transition strategies section).

Applying the following principles ensures effective stakeholder participation in the process of identifying, selecting and implementing projects:

1. **Public invite:** publicise your intention to start planning early and in multiple, accessible locations.
2. **Inclusivity:** ensure all partners are included in teams implementing the Just Transition.
3. **Equal status:** give all partners equal status and equal voting rights at all stages of the transition process.
4. **Information transparency:** provide all partners with the same information, on time and at the same time.
5. **Feedback:** establish clear and transparent routes for feedback.
6. **Go public:** ensure minutes of all meetings are made public within two weeks.
7. **Community engagement:** facilitate public engagement in the transition process and ensure the public are fully informed about it.

GOOD PRACTICE

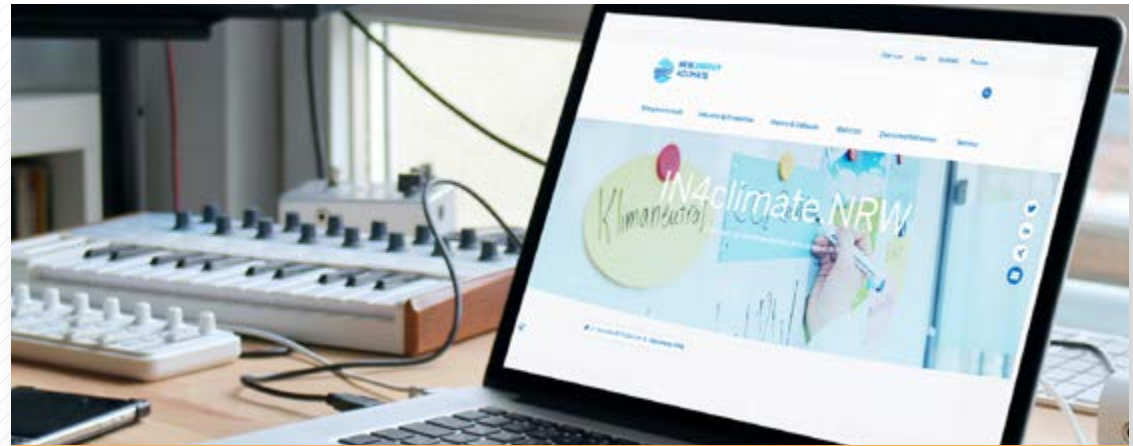

IN4climate.NRW

In North Rhine-Westphalia (NRW), Germany’s industrial heartland, the state government has launched the initiative [‘IN4climate.NRW’](#) to shape and accelerate the transformation of NRW’s industry to a climate-neutral industrial base. The initiative is driven by a joint effort between politics, companies and research institutes. It is important to note that the transition towards a low-carbon economy is not only perceived as a challenge but also as an opportunity to bring innovation and investments to a region that was previously the biggest coal mining region in Europe.

Around 30 companies and associations from the fields of steel and metals, chemicals, cement, glass, paper and building materials are participating in the initiative alongside six research institutes and the NRW state government. The platform is structured in so-called innovation teams that span the topics of circular economy, hydrogen, political conditions, narratives and heat.

As a platform for knowledge sharing, dialogue and collaboration between representatives from industry, science and politics, the initiative offers a space in which to develop innovative strategies for a climate-neutral industrial sector, including new production processes and methods, suitable infrastructure and appropriate political conditions. IN4climate.NRW is accompanied by the scientific competence centre SCI4climate.NRW, which comprises prominent research institutes in the state, provides scientific support and investigates options for developing and organising a climate-neutral and future-proof primary sector. IN4climate is currently looking at how civil society can be involved in the initiative.

→ [Read more](#)

→ [List of innovative projects](#)

‘Lost in participation’: common barriers regions face in stakeholder engagement and examples of how they can be addressed

While the rationale behind stakeholder engagement and partnership building is sound, many organisations struggle to make them work in practice. The following section outlines some of the challenges regions commonly face when implementing comprehensive stakeholder engagement processes as well as some approaches and examples of how they can be addressed.

The process is time consuming and resource intensive

Approach: long-term commitment and clear expectations

Setting up a stakeholder engagement process in the context of regional transitions should be seen as a mid-term (not short- or long-term) process that can, at times, take several years, depending on its scope and complexity. The need to involve multiple sectors, multiple stakeholders and multiple levels while ensuring that legal obligations, planning activities and expert assessments are coordinated all requires a strong commitment from leadership. Stakeholder engagement should start early and be sustained over time. It does not end when a region’s strategy is launched or projects are initiated, as it can also play a key role during the implementation and evaluation phases. Adequate monitoring of the process itself is essential.

Clarity regarding the purpose of the stakeholder engagement process is important and so are

realistic expectations. In this sense, it is advisable to focus on clear communication of the process of stakeholder engagement – its mandate, scope, aim, composition, etc. A well-organised stakeholder engagement process includes setting milestones for decisions early and consistently meeting them. Moreover, clear expectations will help reduce the risk of fatigue and groups abandoning the process because they are unclear on what they are committing to or what will happen next.

It is hard to achieve meaningful inclusion of certain stakeholder groups

Approach: awareness raising, empowering stakeholders and effective facilitation

Engagement processes can face the barrier of there being little interest in, or capacity for, participation among certain stakeholder groups, in particular when they do not have a strong voice.

When it comes to a lack of proactive demand, it is important to remember that stakeholder engagement and awareness raising go hand-in-hand.

Stakeholder engagement can bring attention to areas of the transition that directly affect actors and thus bring them on board. For example, an association for elderly people may become more interested in tackling climate change when made aware of heat islands in their local area that affect the health of association members.

Empowering stakeholders: strengthening the voice of those not usually involved in decision-making can be challenging. Certain stakeholders will require support to be able to meaningfully take part in the engagement process. This can include ensuring they know that they have a mandate to participate and speak as well as providing additional substantive capacity building to enable them to fully participate.

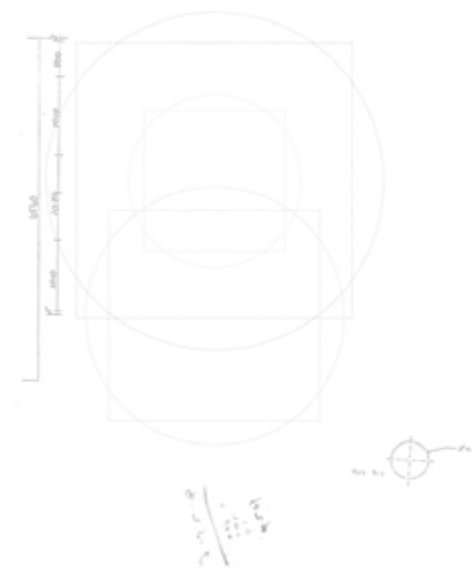

The need to involve multiple sectors, stakeholders and levels requires a strong commitment from leadership

Public participation for the implementation of Just Energy Transition measures in South Africa

In South Africa, the notion of public participation is centrally included in the country's constitution of 1996 by mentioning the need to involve communities in government decision making processes. This has been replicated in many policies and frameworks since then. However, an effective implementation has often been facing many obstacles.

On a national level South Africa has been engaging with the Just Transition for some years. This was taken up by the National Planning Commission (NPC) in 2019 when they ran a series of social dialogue processes across the country engaging with a range of stakeholders including government, labour, business, civil society and communities in each of the country's nine provinces. The intention was to develop consensus towards pathways for a Just Transition to a low carbon society and to bring in the voice of the poor and marginalised on all stages of the transition process. This is particularly evident in the South African context with high levels of poverty and inequality. Consequently, there is a clear policy intention of involving representatives of marginalised groups on regional or community level.

However, based on assessments of the community engagement processes in Western Cape, it was found, for example, that overall government departments do comply with the legislative regulations for participation processes such as holding meetings, posting on websites etc., but this was often seen as a ticking-boxes-exercise. Despite that the systems and governance structures are in place, application and constructive use is often lacking.

It was also found that there is a mismatch between what government officials are expected to and what they actually can do: For instance, in a community meeting discussing electrification of an informal settlement citizens might raise questions regarding formal homes. But this particular official does not have a mandate for housing and cannot give an adequate response other than he or she will pass on a message. This may lead to the situation that community members feel they are not heard and that the official does not return with adequate information.

To tackle these challenges, municipalities, government departments and project developers have to be aware of such implementation challenges and integrate learnings such as stated above into governance processes and the transition cycle. Bottom-up approaches may also serve to overcome systemic barriers as performed by a UK PACT-funded project in the two most coal-dependent municipalities in Mpumalanga (eMalahleni and Steve Tshwete) which aims to co-develop a coherent Just Transition plan that is inclusive of communities that will be affected by the transition. The project has successfully run workshops with labour representatives, communities from the two chosen municipalities, local governments, the energy company Eskom and the business sector, especially focussing on an inclusive transitional justice approach.



Facilitation: it is common to designate an independent organisation to manage and run the stakeholder engagement process. A good facilitator has an in-depth understanding of the technical, political or social issues involved and ensures equal engagement of all stakeholders.

Depending on the context, the role of a facilitator can be to communicate, convene, facilitate or even resolve conflicts. The facilitator must have a clear mandate. Facilitators help ensure that the process stays on track and that participants and the public are adequately informed. Even if the facilitator has been commissioned by a government authority that is part of the process, the facilitating organisation's role must be neutral and in the interest of all parties. This neutrality tends to result in higher acceptance from participants and the public.

There is lack of agreement regarding the information needed to make decisions

Approach: joint fact-finding processes

Stakeholder engagement processes need information on which to base their deliberations. One risk of stakeholder engagement processes is that stakeholders may bring competing pools of data and experts to advance their respective positions.

Solutions exist to avoid contestation of available evidence (the problem of “whose truth” is it) and build objective and constructive stakeholder debates. For example, Joint Fact Finding (JFF) brings together subject-matter experts, decision-makers and stakeholders to frame, review, and use scientific information for policy decisions. An example of an international joint fact-finding process can be found e.g. for the [Fukushima nuclear accident](#).



FIGURE 14

The different levels of stakeholders engagement



PROBLEM

Process is time-consuming and resource-intensive



APPROACH

Long-term commitment and clear expectations

Stakeholder engagement should start early and be sustained over time. It does not end when a region's strategy is launched.



PROBLEM

It is hard to achieve meaningful inclusion of certain stakeholder groups



APPROACH

Awareness raising, empowering stakeholders and effective facilitation

Awareness raising can bring certain stakeholders onboard, while targeted support can strengthen the voice of those not usually involved in decision-making. A good facilitator ensures equal engagement of all stakeholders.



PROBLEM

Lack of agreement regarding information needed to make decisions



APPROACH

Joint fact finding processes

There are solutions to avoid contestation of the evidence available and build objective and constructive stakeholder debates.

Case studies

Stakeholder engagement process in Upper Nitra (Slovakia)

Upper Nitra's Transformation Action Plan is an example of a regional strategy that was developed based on strong stakeholder engagement across various governance levels, in particular the local level (see figure 15).

The first initiators of the engagement process were the local authorities in the region. In January 2018, the mayor of Prievidza, one of the region's mining centres, in cooperation with other local authorities in the region, announced the intention to create an action plan to develop the Upper Nitra region and called on all citizens to contribute to it.

Citizens were informed through local media about the steps they needed to take to engage in the process. They were able to register via email, and there were no limiting criteria on the number or competencies of participants. Sixty people volunteered to participate, including local civil servants, entrepreneurs, heads of schools or social institutions and representatives of NGOs.

Between March and September 2018, fifteen engagement meetings were held. Local stakeholders deliberated and agreed on the priorities and pillars of the region's transformation namely: economy, mobility and social infrastructure. Working groups were formed around these transformation pillars and were headed by regional experts. Support was provided by the Technical University in Bratislava. Moreover, Friends of the Earth-CEPA created a web platform for communicating and sharing information related to the action plan and the stakeholder engagement process to increase awareness and encourage participation of a wider audience.

Local authorities handed the results of the consultation over to the national government in September 2018, which was later validated by local communities via public hearings facilitated by PricewaterhouseCoopers (PwC), who also carried out further data analysis. The costs of the initial consultation process (up to October 2018) were covered by the local authorities and by NGOs, whereas the second stage, facilitated by PwC, was financed through technical assistance funds.

Some of the challenges in the process included the initial absence of the region's main mining company from the consultation process; the company declined to

participate during the first phase. Moreover, there was initially a lack of alignment across different governance levels. In other words, regional and national stakeholders were undertaking separate initiatives and sending different policy signals to the public. A series of developments and key political triggers (e.g. local elections in the region showed support for a transition process, and a national-level resolution to reduce support to coal was issued) led to the final approval of the region's action plan in mid-2019.

[-> Read more](#)

FIGURE 15
Consultation process for the Upper Nitra action plan

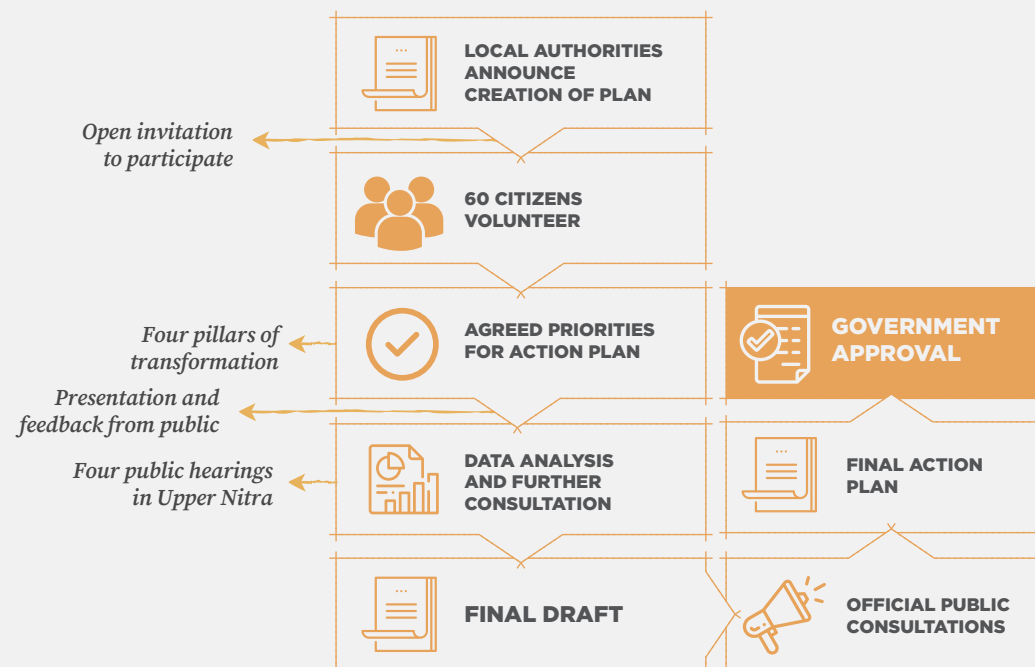

Coal commission in Chile

In Chile, about 70 per cent of electricity comes from fossil fuels, and the country is heavily dependent on imported sources of energy such as oil, coal and gas. However, there is great potential for integrating renewables into the energy mix, be it solar, wind, geothermal or hydroelectric, considering the country's abundance of resources. In 2015, Chile committed to use renewable energy to generate 70 per cent of its electricity by 2050 and announced a plan to phase out coal-fired power plants.

To this end, a **coal commission** was established in 2018 with the goal of developing recommendations for the government and evaluating various exit strategies. The coal commission comprises four companies operating coal plants; three public institutions; one industry association; three consumer associations; two academics; three NGOs; three civil society associations; one municipality; one international agency; and the national electrical coordinator. Other organisations were invited to contribute on relevant topics such as the effects of coal power on human health, international coal phase-out experience, environmental factors, technology alternatives etc. An important element is the involvement of the coal-fired plant operators in this process, who have also signed an official protocol agreeing to decarbonise and declare their willingness to invest in renewable energy at the same time. In 2019, President Sebastian Piera of Chile announced that the phase-out would begin in 2024 with the decommissioning of eight coal-fired power plants and that all coal-fired power plants must be shut down by 2040 at the latest. The original decommissioning schedule has been changed and pushed forward several times.

The coal exit announcement was enhanced by intensive work between different relevant stakeholders who were invited and guided by the Ministry of Energy. The

purpose of this work instance, named **'Phase-out and/or Reconversion of Coal Units Roundtable'** involved multi-sectoral actors including the owners of coal units, the public sector (Ministry of Energy, National Energy Commission and Ministry of Environment) and the National Electrical Coordinator; consumer associations; non-governmental organisations; workers' unions and civil society organisations; municipalities; academia and international organisations. It was supported by the project 'Decarbonisation of the energy sector in Chile' implemented by the Ministry of Energy and the German Agency for International Cooperation (GIZ), within the framework of intergovernmental cooperation between the two countries.

The purpose of this roundtable was to examine the technological, environmental, social, economic, security and sufficiency elements of each thermoelectric unit, as well as the electrical system as a whole, in order to establish the conditions for a gradual and safe phase-out of coal-fired power plants. It was also supported by a strategy document called 'The Plan of Phase-out and/or Reconversion of Coal Units' led by the Energy and Mining Minister Juan Carlos Jobet, which is one of Chile's strategic tools to combat climate change and achieve carbon neutrality by 2050. It focuses on the process of phasing out coal-fired thermoelectric power plants in Chile. A Just Energy Transition Strategy has been launched alongside this to flesh out measures related to social dialogue, private-sector compensation and worker protection.

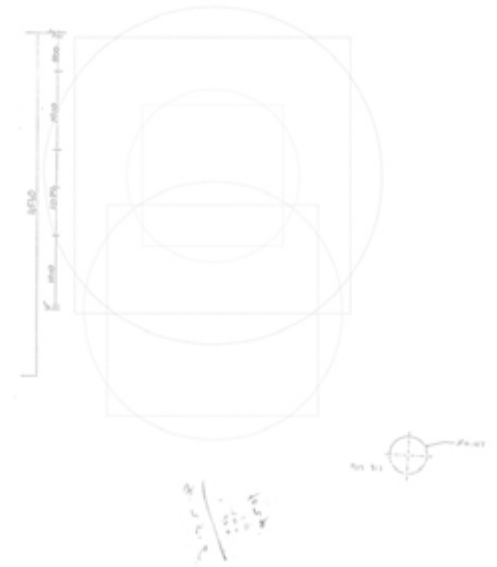

Tools and guidance

The following resources provide guidance on participation formats and specific tools that can be adapted to different target groups. It is worth remembering that specific tools are not to be used in isolation or outside an overarching framework for the process.

Participatory processes for decision-making in policy learning: a methodological proposal

Climate-KIC (2019)

This proposal describes the methodology used for participatory processes in different projects implemented by the Climate-KIC around energy transitions and sustainability challenges. It gives hands-on recommendations about what to do at different stages of the participation process, including problem definition, co-creation processes, workshop design, workshop management, knowledge codification and analysis.

[-> Read more](#)

Participatory governance toolkit

Civicus (2015)

This online toolkit offers information on participatory governance practices, structured according to different aims for participation, stages in the policy cycle and functions of government. It comprises more than 30 individual approaches/tools. Each tool entry provides a brief introduction to the practice, explains how it is carried out, outlines its key benefits, challenges and lessons learned, and links to additional resources (operational manuals, guidelines, articles, reports), individuals or organisations with expertise in using the tool, as well as relevant case studies.

[-> Read more](#)

Participatory methods toolkit: a practitioner's manual

King Baudoin Foundation / Flemish Institute for Science and Technology (2006)

This is a hands-on toolkit for starting up and managing participatory projects. It includes a description of 13 participatory methods. For each method, there is a description of when to use it, its different steps, best practices and budget implications. All of this information is accompanied by various tips and tricks. A section with general guidelines for using participatory methods includes a comparative chart of all outlined methods and a brief overview of 50 additional methods and techniques.

[-> Read more](#)

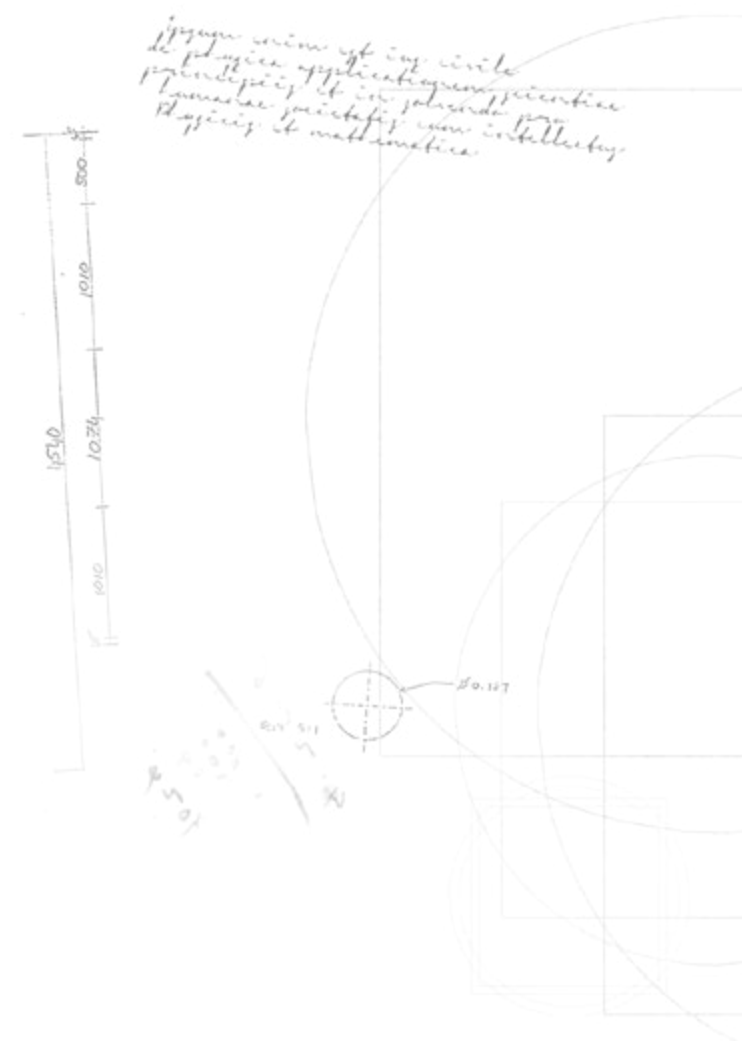

The multi-stakeholder partnerships tool guide

Brouwer / Woodhill (2015)

This guide links the underlying rationale for multi-stakeholder partnerships with a clear, four-phase process model, a set of seven core principles, key ideas for facilitation and 60 participatory tools for analysis, planning and decision-making. It was written to assist those directly involved in multi-stakeholder partnerships, as a stakeholder, leader, facilitator or funder. It provides both the conceptual foundations and practical tools that underpin successful partnerships.

→ [Read more](#)

→ [Online tool overview](#)

Visual toolbox for system innovation

Climate-KIC (2016)

This source book of tools provides support for managing and facilitating sustainability transitions in a participatory way.

→ [Read more](#)

Stakeholder engagement

The Entrepreneurial Discovery Process as a form of stakeholder engagement has been used by coal regions in the EU for the design of a Smart Specialisation Strategy. It involves holding workshops and other interactions within the region, in which different stakeholders build working relationships, share ideas and knowledge, and agree on a common vision and priorities rooted in the region's strengths (or "specialisation").

Online tools

The S3 [online toolbox](#) on smart specialisation suggests three online applications that can be used to foster discussion: 'Discuto', 'DebateGraph' and 'S3Engagement'. Each tool helps facilitators to engage stakeholders in strategy and planning deliberation processes at low cost, while increasing transparency and legitimacy. They allow stakeholders to provide feedback, vote on and discuss ideas and documents.

Citizen dialogues and citizen juries

Broad-based engagement of civil society can occur through citizen dialogues and citizen juries, which typically involve facilitated discussions of randomly selected and demographically representative community members, open conferences and moderated online fora. Some examples include the Canada's citizen dialogue [Future Energy Dialogue](#) or Australia's [Citizens' Jury on Energy](#). Examples at the regional level include the [Rural Energy Dialogues](#) in the USA or [Lusatia's Citizens' Dialogue](#) in Germany.

Further expertise

A broad range of knowledge and resources regarding stakeholder engagement and public participation processes around the world are provided by several organisations, e.g. [Participedia](#), [Involve](#), [International Association for Public Participation](#) and [Sciencewise](#).

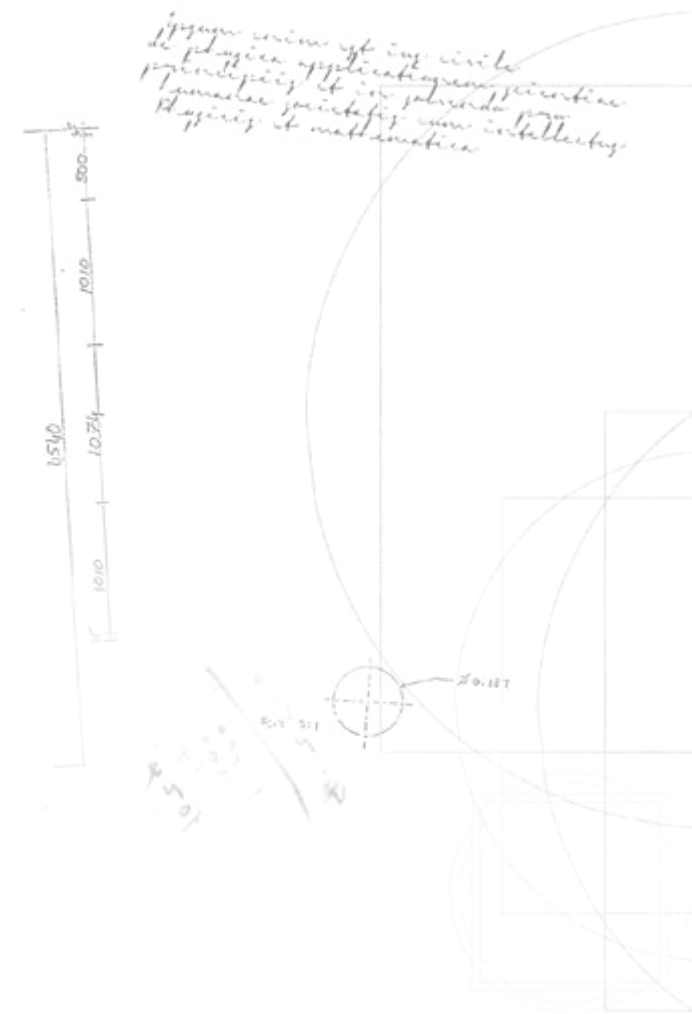

Social dialogue

Successful social dialogue structures and processes that anticipate future needs and changes are key to ensure Just Transitions. Social dialogue has provided the basis for crafting and implementing important agreements on wages, compensation plans, reskilling programmes and other measures in coal regions in transition.

The ILO's [Guidelines on a Just Transition towards environmentally-sustainable economies and societies for all](#), which were jointly developed by government, employers and worker groups, stress the importance of social dialogue in the transition process. This is particularly true at a regional level due to the special needs and characteristics of regions.

Evidence from various regions shows how the presence of effective social dialogues can result in a more socially just and balanced transition process. For instance, social dialogue plays an important role in handling potential conflicts between environmental protection and employment priorities.

Unions' know-how regarding industrial sectors and their roles as brokers of knowledge needed to inform decisions is increasingly recognised as essential to transition processes. Worker organisations are able to identify and implement measures aimed at attracting new businesses and investment and to partner with other stakeholder groups to advance common goals. In fact, so-called blue-green alliances between labour groups and environmental protection advocacy groups have been a key to success in many processes.

Specific examples of the role played by social dialogue and of trade union participation in transition processes in coal and industrial transition regions are outlined below.



Examples from coal regions in transition

Canada

The Canadian government established a *Task Force on Just Transition for Canadian Coal and Power Workers and Communities* to accelerate the coal transition in Canada. The task force aims to engage directly with local communities and workers in determining the right strategies and possible future challenges involved in the coal transition for the Canadian Minister of Environment and Climate Change. The task force comprises small groups of experts including affected regions and workforce representatives. Members of the task force travelled to 15 coal communities in Canada, met with more than 80 stakeholders and hosted eight public engagement sessions for the general public and conducted study tours at five power plants, two coal mines and one port in the affected regions. In early 2019, the Canadian task force presented the government with recommendations for a plan of action, which the government now intends to implement within the framework of its proposed 'Just Transition Act'. The work of the taskforce was widely praised across stakeholder groups and can serve as a blueprint for other coal regions across the globe.

Spain

The Framework Agreement for a Just Transition in Spain's Coal Regions, also known as the *Spanish Coal Plan* arose from negotiations between government, employers and workers and is a well-known example of an agreement reached through social dialogue that also aims to address the specific needs of coal regions. This dialogue was centred around mine closures and took place between trade unions, mining

companies and different levels of government. The plan mostly focused on the short-term effects of phase-out rather than on a broader development strategy for the regions. Other actors in the field of regional development were not involved.

Germany

In the Saarland and Ruhr regions in Germany, the energy and miners' unions were important actors in facilitating the transition process that took place from the 1950s to 2018. A collective bargaining process resulted in agreements being reached on wages, compensation plans, qualification/retraining initiatives and other measures. Related to the Ruhr's regional transition is the process of establishing a climate protection law in the German federal state of North-Rhine Westphalia. This resulted from a long dialogue process, which included important contributions from unions. The trade union organisations that were involved in preparing the state's climate plan (IG Metall, IG BCE, Ver.di, IG BAU and DGB NRW) participated in all six working groups of the dialogue process, with DGB NRW also being represented within the central coordination platform.

Following consultation, the trade union organisations, under the coordination of DGB NRW, adopted a common position in which they declared that they found the plan's objectives reasonable, and they restated their commitment to combining climate protection with a socially sustainable transition that creates jobs.

United Kingdom

The region of Yorkshire and the Humber is the most industry-intensive in the UK and the second biggest energy consumer, accounting for roughly 10 per cent of the UK's CO₂ emissions. The Yorkshire and Humber TUC Low Carbon Task Force is a project of the Trades Union Congress that has led to a partnership among unions, business, local enterprise partnerships (industry and business support groups) and environmental groups, such as Sheffield Climate Alliance and Friends of the Earth. The goal of the partnership is to build a Just Transition strategy and leverage the resources needed to deliver it.

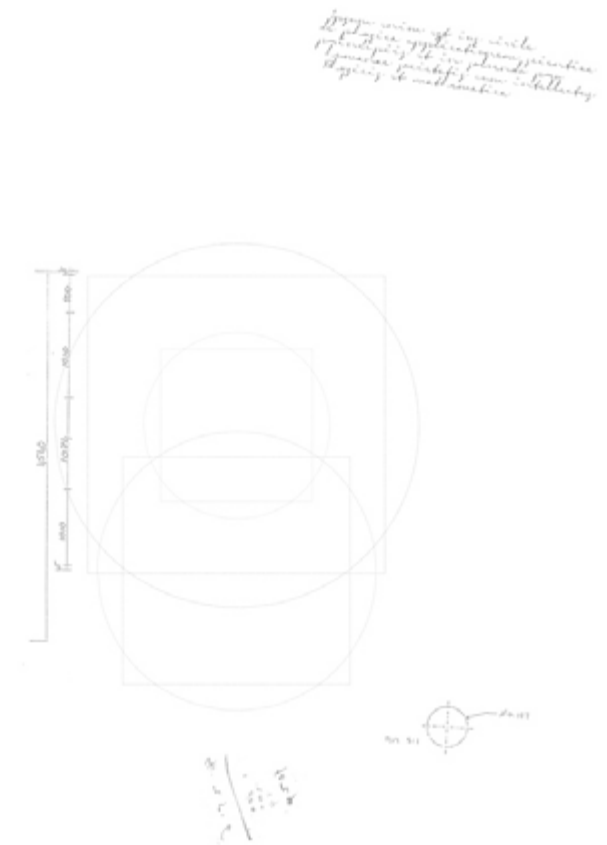

The role of civil society

The involvement of civil society in the transition process is vital for successful governance. Some of the advantages of civil society organisations (CSO) involvement include that this:

- Increases a sense of ownership and legitimacy of the process, and can help address power imbalances and/or vested interests.
- Reduces the risk of opposition to the transition process in later stages (as is the case with stakeholder engagement in general).
- Captures the much-needed know-how, contacts, local knowledge, social capital and even material resources held by local civil society organisations.
- Has knock-on benefits, as local CSOs can act as gatekeepers and multipliers for whole groups of citizens.
- Engages CSOs as effective representatives of certain groups within a wider community, acting as a vehicle to make their voices heard (e.g. minorities, women, indigenous people, etc.).
- Expands citizen involvement.
- Can trigger the start of a transition process or be the key to overcoming a specific challenge.

CSOs can span different geographical scopes and types, from community-based organisations and grass-roots movements, to national and international non-governmental organisations.

Examples from coal regions in transition

There are a number of obstacles to the involvement of CSOs in regional transitions. Local transition leaders sometimes see CSOs as vehicles to build social acceptance rather than as powerful partners in the transition. CSOs often face barriers to their involvement in the transition due to adverse political contexts that constrain their engagement, a culture of not being consulted and deemed legitimate, or internal factors such as limited resources or capacity.

The following examples shed light on the role that CSOs play in coal regions in transition and how their role can be further promoted.

'Locals activate locals'

Local NGOs are often more effective than national or international ones at mobilising citizens at the local or regional level. This presents an opportunity for partnership to bolster the effectiveness of international NGO efforts and the resources of local ones.

Germanwatch and Bankwatch are examples of international NGOs that partner with local organisations and individuals who are, in turn, able to galvanise the local community.

Germanwatch has partnered with local CSOs in Ukraine. Some keys to their success were the organisation's experience in facilitation and the breadth of experience they had from other regions, which they applied to this new setting. They also developed local decision-makers' knowledge through a baseline study.

Bankwatch and Greenpeace facilitated a partnership agreement between six localities in the Jiu Valley in Romania. The process was aided by the NGOs funding a report on the options for fair and sustainable economic diversification, which acted as a focal point for discussions between the government and civil society actors.

Funding for Civil Society Organisations

In the United States, the Just Transition Fund was put in place by philanthropic initiatives (the Rockefeller Family Fund and the Appalachia Funders Network) to support local networks, including grassroots groups, trade unions, and small businesses, in designing transition projects for their communities, and presenting them to funding agencies. This represents a good example of encouraging civil society involvement through top-down funds, based on, and interlinking with, a broader transition policy. Projects that were supported ranged from those to strengthen the tourism sector, to ones to support social enterprise incubation, and to undertake feasibility studies for developing local capacity for solar panel manufacturing.

**The involvement
of civil society
in the transition
process is vital
for successful
governance**

Further resources

Sareen, S. (Ed), 2020 : Enabling Sustainable Energy Transitions: Practices of legitimation and accountable governance

This book illustrates a framework for sustainable energy transition with regards to legitimation and governance. It highlights a number of practical examples to identify the role of legitimation and accountability in a sustainable energy transition.

→ [Read more](#)

Coal Transition Research Hub

Coal Transition is an international research hub which aims to collect credible and feasible trajectories and policy guidance for deep transitions in the coal sector in major coal producing and consuming countries.

→ [Read more](#)

Urban Transition Alliance

The Urban Transitions Alliance aims to support industrial and former industrial cities across the world to become global leaders in sustainable urban development. The Alliance provides infrastructure and support measures to identify common challenges, share knowledge, co-create solutions and forge relationships with local government peers, experts from the research community and private sector solution providers.

→ [Read more](#)

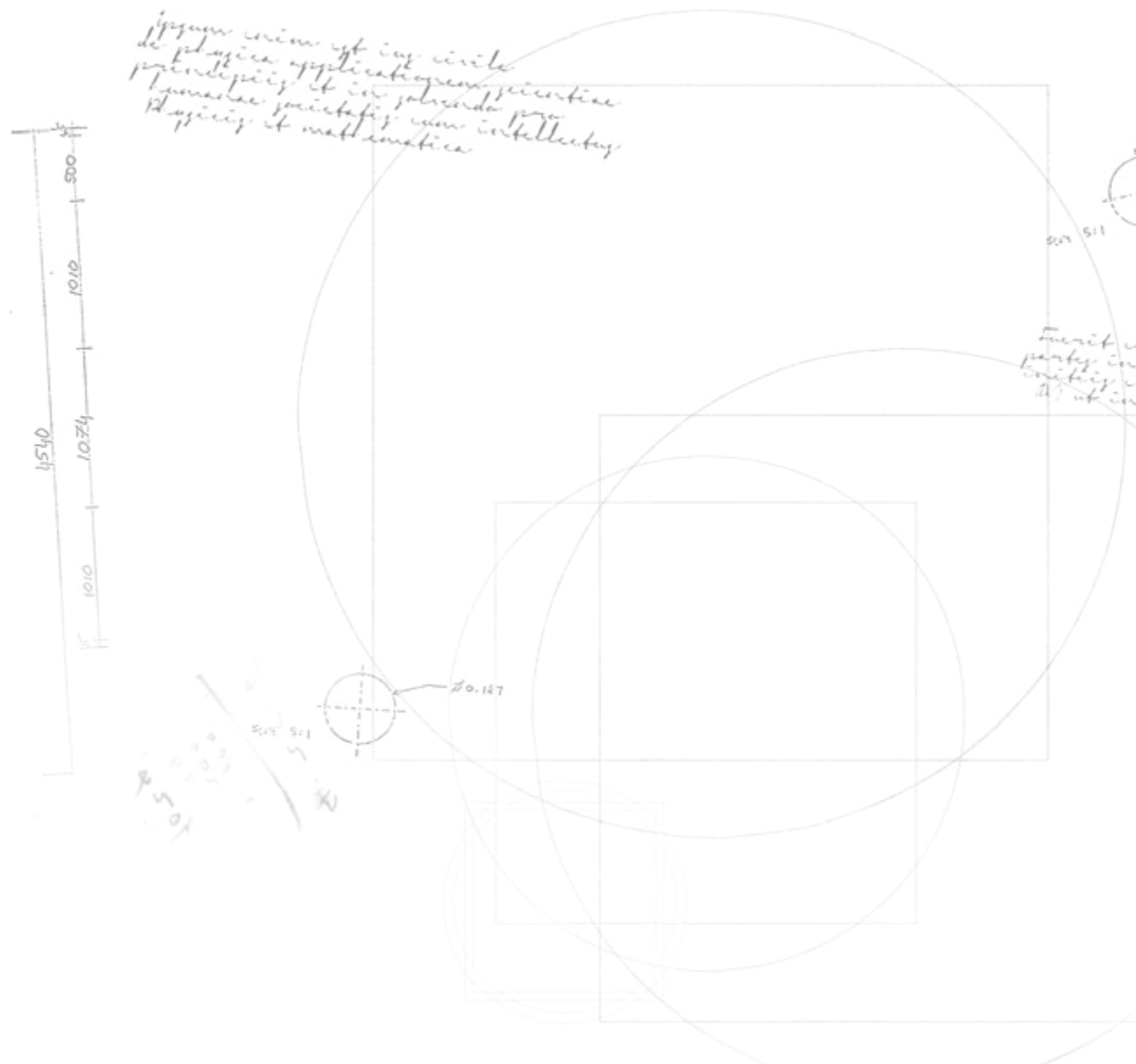

*Ipsum enim est in civitate
de physica, mathematica, scientia
principio et in solvendo pro
quibusdam scientiis, non intellectibus
logice et mathematica*

$$\int \frac{dx}{x^2} = -\frac{1}{x} + C$$
$$E(t) = \frac{1}{t}$$



*Facit enim ingenium primario
partem investigandi etiam non primario
modo, sed in parte, in parte
et in parte, in parte et in parte*

$$\frac{1000}{100} = 10$$

3

Making the shift from

fossil to renewable energy

KEY MESSAGES

The energy system of the future will ideally be developed in line with the three indicators environmental sustainability, energy security and energy equity.

By 2050, almost 90 per cent of electricity will come from renewable energy, while fossil fuels will only make up 3 per cent of the total electricity generated.

Key renewable technologies are solar PV and wind energy, combined with various types of energy storage.

The use of fossil gas and biomass use for energy production poses a significant risk of becoming stranded assets. They should only be considered in the short term (gas) and with secured sustainable feedstock in small-scale applications (biomass).

Nuclear energy and (dam-based) hydropower have some specific downsides and risks regarding safety, impact and costs that should be taken into account.

Mining land and coal power stations should be treated as assets to attract new businesses and create new jobs in the region.

Repurposing options depend on the site-specific characteristics and can range from the installation of renewables, to energy storage on industrial and manufacturing sites, through to data centres, office space, etc.

Overview

Solid background knowledge regarding the technological options for an energy transition, including the development potentials and risks, will help regional decision-makers and stakeholders to maximise the economic benefits of this transition for coal regions.

RENEWABLE ENERGY PRODUCTION

Solar
Wind
Geothermal
Marine energy
Energy storage

-> [Go to section](#)

ENERGY TECHNOLOGIES WITH UNCERTAIN PROSPECTS

(Fossil) natural gas
Bioenergy
Hydropower
Nuclear energy

-> [Go to section](#)

COAL-RELATED INFRASTRUCTURE REPURPOSING

An overview of the challenges and risks involved in repurposing from a policy perspective and repurposing options for

-> coal mining areas

-> coal power plants



Introduction

Why the energy transition is necessary

The energy transition towards a climate-neutral economy implies a fundamental shift in technologies (from fossil to clean energy) and requires large and long-term investments. Making use of existing infrastructure and sustaining existing value chains in the coal and coal-related sectors will be key to making this transition more cost-efficient and to keeping jobs and wealth creation in the regions.

Given the long investment cycles in the energy sector, it is clear that investments today need to be in line with the long-term goal of a climate neutral economy. Generally, investment decisions are made by private companies (e.g., energy utilities and companies in energy-intensive industries). However, the specific conditions of a region (e.g., infrastructure, skilled workforce, potential partners along the value chain) will be decisive for giving a site the competitive edge over global alternatives. Consequently, a key question for regional decision-makers is: under which conditions are companies willing to further invest in a specific site? Many of these conditions are beyond what individual private investors can influence directly. Building future-proof infrastructure (e.g., for electricity and hydrogen), establishing new production facilities and improving a region's innovation system – all this requires a collective effort by the public and private sectors, companies, administrations, research organisations and educational institutions.

If properly facilitated, a just energy transition can not only shift energy production towards

a more sustainable one, but can also improve energy systems in these three major indicators:

- **Environmental sustainability** – reduction in energy, CO₂ intensity, and environmental pollution; transition to renewable and zero-carbon energy sources.
- **Energy security** – management of the primary energy supply from domestic and external sources, reliability of energy infrastructure, ability to meet current and future demand.
- **Energy equity** – accessibility and affordability of the energy supply across the population.

To facilitate this collective effort, it is necessary that all stakeholders in a region possess a basic knowledge of key technology options that are in line with the requirements of the transition to a climate-neutral economy. With this in mind, this section provides a brief overview of key technology options that are of high relevance for coal regions; specifically, it explores low-carbon options for energy production from different renewable technologies, including energy storage systems. Furthermore, this section offers an overview on how to deal with coal mine closures and the repurposing of mining sites and how the infrastructure linked to coal-fired power plants can be reused after closure.

Issues relating to energy transitions and the reuse of existing energy infrastructure (e.g., coal-fired power plants) should be embedded in the overall development of a strategy for the region (see "[Developing strategies for a Just Transition in coal regions](#)" on page 17) and serve to make the regional economy viable for the future while retaining jobs in the region (see "[Paving the way for new business opportunities and sustainable employment](#)" on page 115).



It is necessary that all regional stakeholders possess a basic knowledge of key technology options in line with the requirements of the transition to a climate neutral economy

Renewable energy technologies

The rapid development of large shares of renewable energy will inevitably become necessary in the coming decade in order to decarbonise power systems. Projections indicate that renewable energy will reach a share of between 40 and 60 per cent of the total final energy consumption in most countries by 2050, according to the different scenarios which aim to project development paths to reach the 1.5 degree target of the Paris Agreement. For instance, both the International Energy Agency (IEA) and the International Renewable Energy Association (IRENA) calculated that renewable power could reach approximately 10,000 GW globally in 2030, which is more than four times the current capacity.

By 2050, almost 90 per cent of electricity will come from renewable energy, with solar and wind accounting for nearly 70 per cent (see figure 16). Fossil fuels will only make up 3 per cent of the total electricity generated. This remaining share of fossil fuels will be primarily used in sectors where low emission technology options are limited or in facilities with CCUS (see box "CCUS in the energy system of the future" on page 70).

The trend towards renewable technologies is not only a consequence of the efforts to switch to cleaner energy production methods; it is also due to the falling cost of renewables, which are now cost-competitive and oftentimes even cheaper than producing electricity from coal or natural gas. For example, electricity from utility-scale solar photovoltaics cost USD 359 per MWh in 2009 (LCOE, levelised costs of energy¹) – yet, within one decade, the price declined by 89 per cent to USD 40 per MWh.

The following section provides an overview of the different technologies that will play the most prominent role in decarbonising today's energy systems. The challenges and opportunities presented by potential bridge technologies are also discussed.

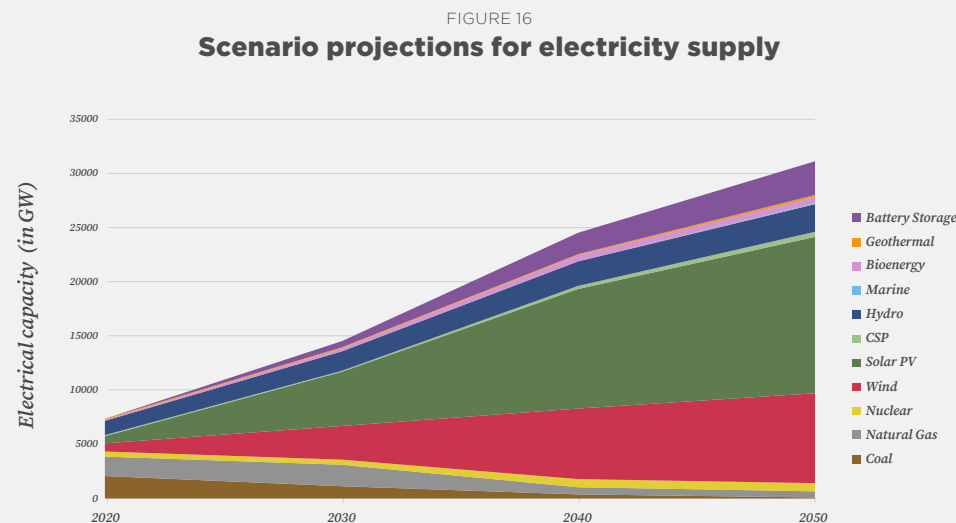

Source: IEA 2021

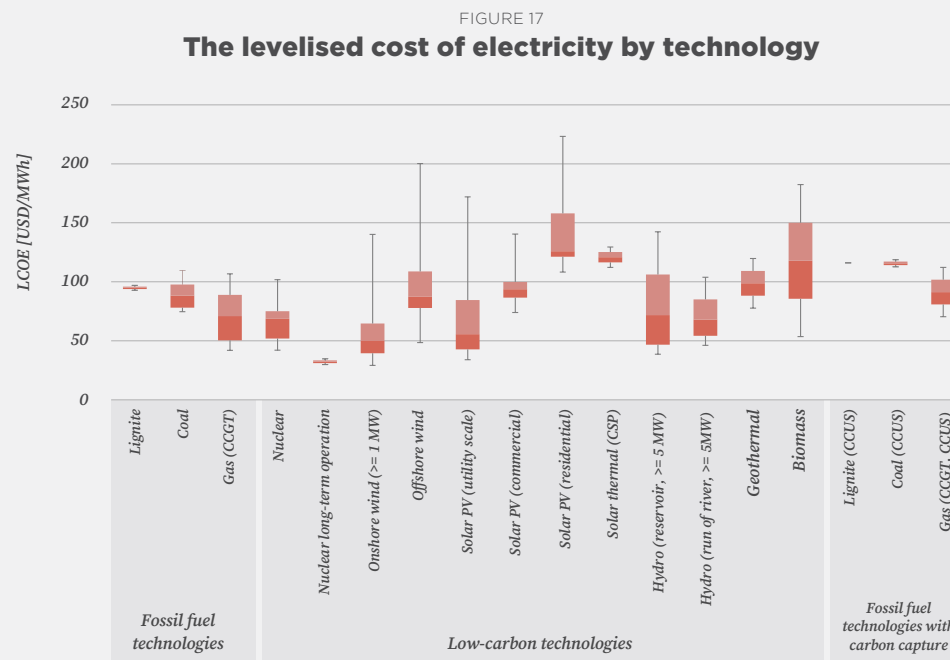

Note: Values at 7% discount rate. Box plots indicate maximum, median and minimum values. The boxes indicate the central 50% of values, i.e. the second and the third quartile.

¹ LCOE captures lifecycle costs, which include the costs of building the power plant itself as well the ongoing costs for operating the power plant over a certain estimated timespan. Details on how the reference LCOE are calculated can be found in IEA (2020), *Projected Costs of Generating Electricity 2020*.

Source: IEA (2020)



CCUS in the energy system of the future

During the 1990s and early 2000s, there were high expectations for the potential carbon capture and storage (CCS) offers in terms of climate mitigation and reducing the CO₂ emissions of coal- and gas-fired power plants. However, efforts to implement projects have been slow. In 2020, only 26 commercial CCS facilities were in operation globally and only the 115-MW Boundary Dam in Canada is connected to a coal-fired power plant (but failing to meet its objectives). In the context of power generation, this development is mostly due to the fact that capture costs did not decrease as expected, and CCS could not compete with the cost reductions of renewables. Furthermore, CCS faces acceptance problems in some countries which also put projects on hold.

In recent years, the debate shifted from CCS as an option to prolong the lifetimes of existing carbon-based energy production facilities to a focus on carbon capture usage and storage (CCUS, also see box "Carbon capture, usage and storage (CCUS) / negative emissions technologies" on page 107) in the form of direct air capture. This is mostly due to the insight that carbon needs to be stored permanently; however, storage capacities are limited and the impacts of long-term storage are largely uncertain. This led to the conclusion that it is better to use carbon rather than simply storing it.

The recent Net Zero by 2050 report from the International Energy Agency projects approx. 400 GW of fossil-based power production with CCUS to stabilise global emissions. However, 400 GW of power capacities account only for about 1 per cent of the projected total energy production in 2050, which indicates that its applicability will be limited. From a climate perspective, it should be noted that CCUS can potentially reduce a substantial amount of emissions from coal and gas-fired power plants, but not down to zero. Considering the age structure of power plants in most countries and that the world is aiming to become climate neutral, CCUS is hardly a valid option for most coal plants. Regarding the power sector, coal regions should not place too much hope in CCUS technologies – CCUS is costly, not yet sufficiently mature as regards its technology, and will be required primarily in sectors where carbon emissions are especially hard to abate, e.g., the steel or cement industry (see "The role of energy-intensive industries for the transition" on page 99).

Solar energy

Solar energy is likely to become the most important source for electricity generation in the future. Even considering geographic restrictions, technological limitations and economic factors, the [World Bank](#) calculated that the electricity generation potential from solar photovoltaic (PV) sources in most countries exceeds their current electricity demand.

While solar energy was often described to be an expensive energy source in the past, this is no longer the case. As solar technologies have been making rapid leaps in development and reaching economies of scale, module prices are also dropping: the global levelised cost of energy (LCOE) of solar averaged USD 56/MWh in 2020. According to IRENA, the price of electricity from solar is expected to fall even further, to as low as USD 10/MWh to USD 50/MWh (see also figure 17). This makes solar PV one of the cheapest energy production sources – beating coal-fired power plants in many places. In light of this, it is foreseeable that solar energy will play a major role in the future energy mix. According to the net zero emission scenario of the International Energy Agency (IEA), global solar PV capacities could reach up to 14 TW in 2050 (see figure 16).

Solar radiation can be used to produce heat, chemical energy, but most importantly electricity:

- Photovoltaics (PV): as modular systems, PV can be applied both at small-scale and large-scale facilities, close to consumers as rooftop PV or on solar farms in the countryside – including to reuse old mining sites, e.g., in [Morrison Busty, UK](#). They can be connected to a grid system or work as off-grid power stations in regions that have not been connected to power networks yet.
- Concentrating solar power (CSP) uses heat from the sun to drive utility scale turbines for electricity generation. CSP requires high levels of direct solar radiation, making it more suitable for countries

GOOD PRACTICE



Global Solar Atlas

The [Global Solar Atlas](#) is a web-based tool provided by the World Bank which summarises global solar power potential and solar resources. The data provided allows a virtual comparison and evaluation of solar energy potential for any region or country.

or regions with high solar radiation levels and very few clouds. Combining it with heat storage could increase availability and reliability. However, the costs of electricity from CSP are currently higher than PV. The IEA's net zero emissions scenario estimates the global potential for concentrating solar power in 2050 to be 400 GW – which is substantial, but much smaller than that for PV.

Compared to fossil fuels such as coal, oil and natural gas, solar energy systems do not produce similar quantities of air pollutants or carbon dioxide emissions. According to the IPCC, utility-scale solar PV produces approximately 18–180 (gCO₂eq/kWh) and rooftop solar PV ranges from 26–60 (gCO₂eq/kWh). Coal, on the other hand, produces almost three times the emissions, between 740 and 910 (gCO₂eq/kWh).

Due to the rapid growth in renewable energy as well as the urgency for more ambitious climate and energy transition policies, employment in the solar industry is expected to expand significantly in the coming years. According to IRENA, employment in the solar industry could exceed 11.7 million jobs in 2030 and 18.7 million in 2050 (see also page 113).

One of the biggest challenges in terms of integrating solar energy is its intermittent nature, which has a great impact on the grid integration of solar energy. Additionally, the amount of radiation varies depending on location, time of the day and weather conditions, resulting in limitations to its reliability as well. For this reason, solar needs to be applied in line with local and regional specifics and matched with energy storage systems and other forms of renewables.

Regardless of the challenges, solar energy is expected to become the most important renewable technology in the global energy mix of the future. Mitigating barriers through policy support is critical at both a regional and national level to boost the future deployment of solar energy.

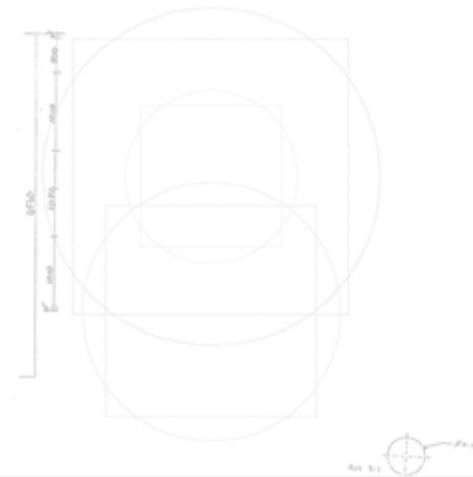
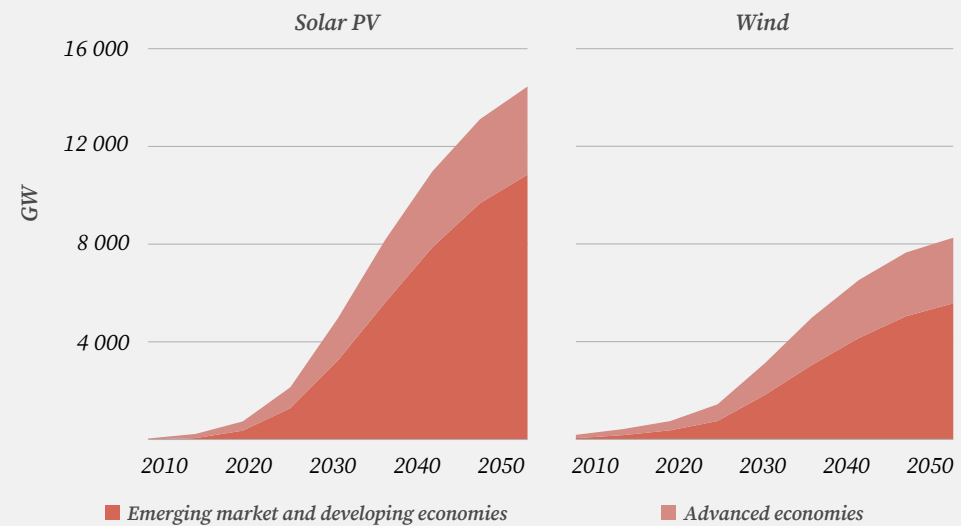

FIGURE 18
Solar PV and wind installed capacity in the Net Zero Emissions scenario (NZE)



Solar PV and wind need to scale up rapidly to decarbonise electricity, with total solar PV capacity growing 20-fold and wind 11-fold by 2050.

Wind energy

Another clean and unlimited resource, wind energy can be considered the second backbone of the energy system of the future. According to the Intergovernmental Panel on Climate Change (IPCC), wind power has one of the lowest CO₂ emissions at 11–12 g/kWh. The amount of electricity produced basically depends on the power of the wind as well as the size of the turbine and length of its blade. The two major types of wind farms are offshore and onshore. Onshore wind farms are easier to install and maintain, resulting in a lower levelised cost of energy of USD 50/MWh compared to offshore wind farms with an LCOE of 88 USD/MWh. However, onshore wind can be slightly less predictable and reliable due to less constant wind currents. This, in turn, is a benefit of offshore wind farms, which are normally built directly on the ocean at a distance from the coastline where the wind blows more consistently and with greater force. Furthermore, it may prove easier to implement projects as pre-existing obstructions, land rights issues or citizens' protests against wind energy in their immediate neighbourhoods do not play a role for offshore wind. Globally, the installed electrical capacity of wind power is projected at around 8,300 GW in the IEA Net Zero Emissions (NZE) scenario by 2050. In particular, Asian countries with long coastlines and respective regulatory frameworks have vast opportunities to install a major share of new offshore wind farms over the next decade.

Like solar energy, wind power is variable and needs to be combined with backup energy storage technologies and used in conjunction with other renewable energy sources in the long term to maintain a constant supply of energy at all times.

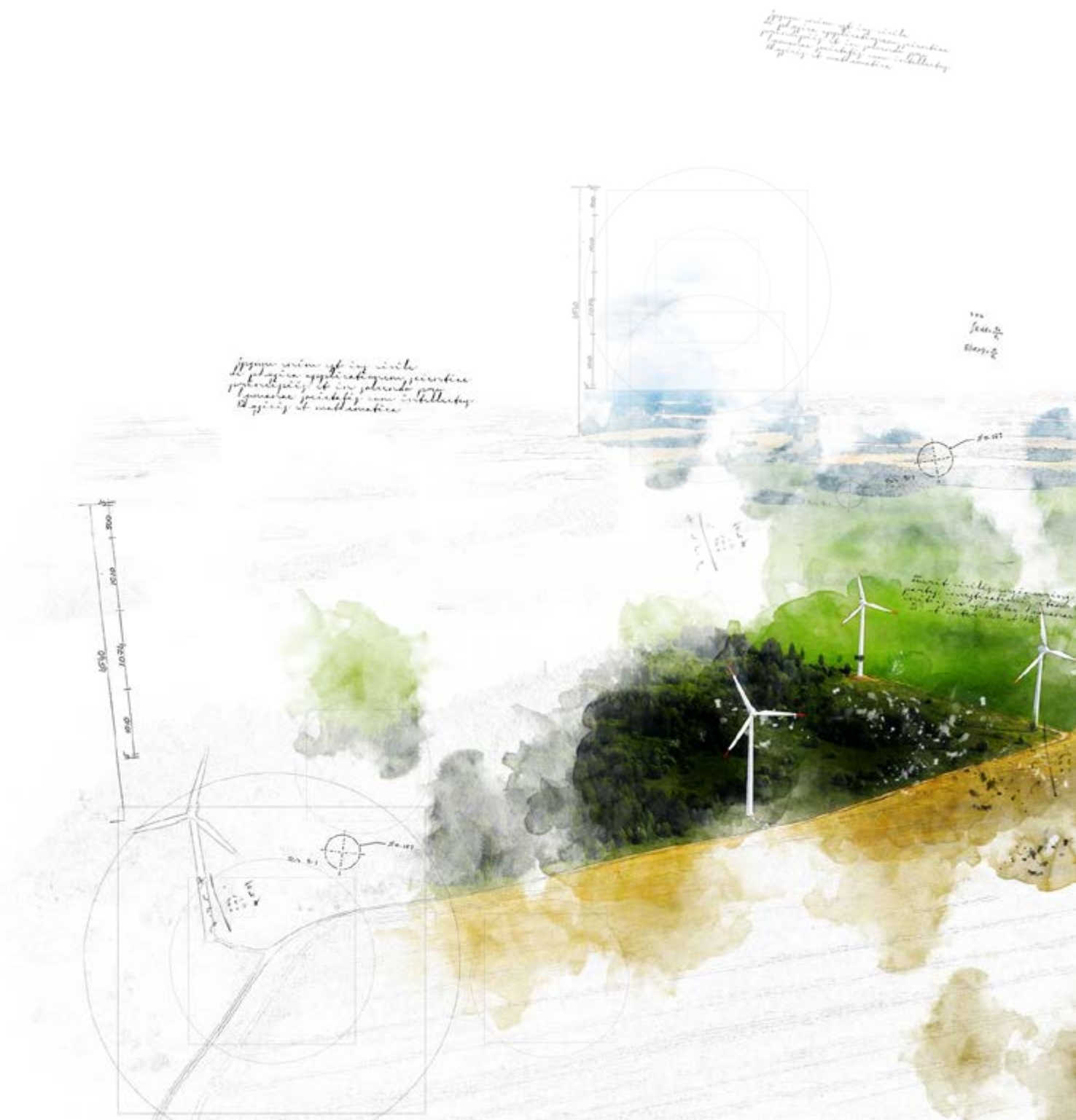

Geothermal

Geothermal energy makes use of naturally occurring hot water reserves in the sub-surface of the Earth for heating and cooling purposes. Deep geothermal energy is a commercially proven renewable form of energy that can be used for base-load or flexible energy production or a combination of heat and power generation.

Its application is dependent on the geographical distribution of heat within the Earth's crust, which is highly variable and mostly found in areas with active tectonic plate boundaries or volcanoes (see figure 19).

Since geothermal energy is not impacted by global depletion of resources, unleashing its full potential could deliver substantial benefits such as lower life-cycle greenhouse gas emissions and provide a dependable baseload power generating contribution to the grid. Geothermal power projects have a high upfront cost due to exploration and drilling operations. These can be financially risky and require some time, ranging from several months to years. Initial public funding may therefore provide support to mitigate the risks for private investors and accelerate the deployment of geothermal energy. The global weighted-average LCOE of geothermal power is USD 99/MWh. In 2015, geothermal power plants generated around 0.3 per cent of global electricity amounting to 80.9 TWh and are expected to become the source of around 2 to 4 per cent of the global energy demand in 2050. This figure appears low, yet for some countries and regions the potential is significantly higher: Indonesia, for example, identified locations with a cumulative geothermal potential of 29 GW. The country is already home to three of the world's largest geothermal power plants today with the largest, Gunung Salak, producing 377 MW of electricity. In addition, Indonesia's latest electricity supply business plan (RUPTL) outlines plans for an additional 2.6 GW of geothermal energy capacities, which means a total capacity of 4,795 MW in 2030.

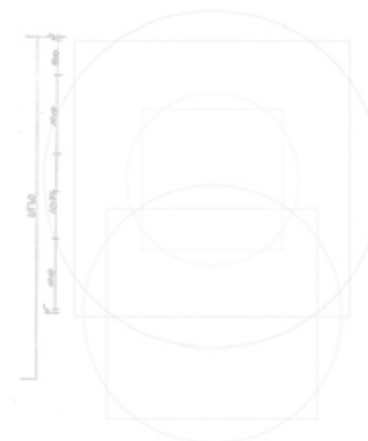
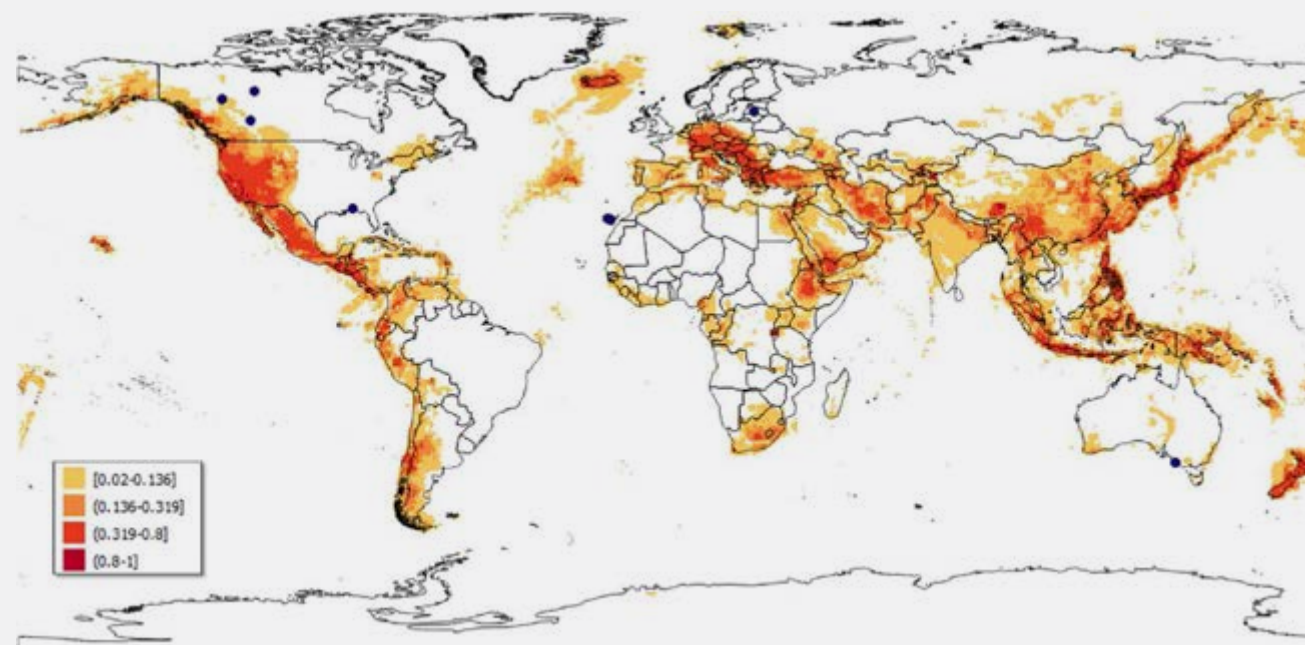

FIGURE 19

Predicted optimal geographical locations for geothermal power plants



Source: Cora/Trumpy 2020
Note: Warmer colours indicate higher suitability scores. Dots indicate geothermal power plants.

Marine energy

Marine energy, sometimes also referred to as [ocean energy](#), aims to make use of the kinetic and mechanical energy that is transported in the form of waves and currents. Both of these technologies have a rather niche potential yet should not be overlooked. Under the IEA's [NZE scenario](#), marine energy capacity would increase to 55 GW in 2050, which accounts for less than a 1 per cent share of the global energy mix. Given that neither technology can be considered market ready as of yet, policy support and investments in research and development are also crucial to reduce the costs and accelerate deployment on a large scale. In countries and regions that have extensive maritime areas, renewable marine energy may provide socio-economic opportunities in the mid- to long-term future.

Energy storage

Small shares of intermittent renewables like solar and wind can generally be integrated quite easily into the electricity mix. However, higher shares eventually call for energy storage technologies to serve as back-up supply when solar and wind provide less power. Consequently, most studies project a significant increase in demand for electricity storage between 2030 and 2040. In the [IEA net zero scenario](#), global electrical capacities for energy storages will grow from 18 GW in 2020 to 3,000 GW in 2050. Many coal regions have significant potential to host energy storage technologies in future, since today's coal-related infrastructure like power plants and electricity grids can be used or repurposed as energy storage facilities. This can help to ease the transition and keep jobs in coal regions. Examples of coal infrastructure repurposing are provided in "[Coal-related infrastructure repurposing](#)" on page 86. This section offers a brief introduction to key energy storage technologies.

A large number of energy storage technologies are already available today, ranging from thermal storage and pumped hydro storage, to various electrochemical battery-based storage solutions. They differ fundamentally in terms of their operating principles and associated capacities (storage volume) and performance (input/output capacity). The competitiveness of electrochemical battery-based storage has increased significantly over the

past few years, and it is already competitive in some markets. However, some estimates indicate that even in the case of further significant cost reductions, batteries may still struggle to achieve high market share as long as carbon prices stay low. Long-term and seasonal storage volumes in particular tend to be more expensive, while storage suitable for short-term balancing will be more competitive.

TABLE 1
Key characteristics of energy storage technologies

	Max Power Rating (MW)	Discharge time	Estimated lifetime	Efficiency	Development stage
Thermal storage	50–400 (molten salt)	1–24 hours	Approx. 30 years	40–80% (molten salt)	Market ready
	up to 1,000 (Carnot battery)			80–90% (Carnot battery)	Pilot stage
Pumped hydro storage	Up to 3,000	Several hours–days	30–60 years	70–85%	Market ready
Compressed air	2–500	2–30 hours	20–50 years	40–70%	Market ready (only CAES)
Flywheel	<1–30	Seconds–several hours	50–60 years (20,000–100,000 cycles)	70–95%	Market ready
Electrochemical battery	Up to 1,000	1 min to 8 hours	10–20 years (1,000–10,000 cycles)	65–95%	Market ready (Li-Ion)

Source: [World Energy Council 2019](#)

Thermal energy storage

Thermal energy storage (TES) will be a key component of future energy systems. This is not only due to the fact that there is a need to help balance energy demand but also that half of the total final energy consumption worldwide can be attributed to heat. New technologies with higher efficiencies are expected to become market ready by 2025 to 2030.

A range of different materials is currently used for such thermal storage facilities, ranging from (molten) salts, to water, silicon, volcanic stones, compressed air or miscibility gap alloys. Some of these options are already in use, e.g., molten salt energy high temperature storage systems based on nitrate salts have been used commercially in solar thermal power plants (CSP) for several years, with efficiency rates of 40–80 per cent. Other options are still in the development stage. Based on current knowledge, capacities up to 1 GWh can be realised.

New technology developments

Carnot batteries are an emerging technology for comparatively inexpensive and site-independent storage of electric energy with high capacities up to 1,000 MWh. A Carnot battery also uses molten salt or water as the storage media and transforms electricity into thermal energy and back to electricity as required. Compared to other thermal storage technologies such as pressurised water tanks, the Carnot battery is able to achieve higher storage efficiencies (from electricity to electricity) with lower energy losses. Initial prototypes of this technology are currently being tested by several institutions, e.g., at energy start-up [MALTA](#) and at the [German Aerospace Centre \(DLR\)](#), with aims to start pilots at thermal power plants.

-> [Read more](#)

Miscibility gap alloys (MGA) are a new material used for thermal heating that work with phase change storing, which provides additional storage for sensible heat and can work up to very high temperatures of over 1,400 degrees Celsius. Research shows that the technology can be cost-competitive with other thermal storage methods. Its modular scalability also offers opportunities for a gradual transition away from coal-fired power plants, an approach that is currently under development, with an initial pilot to be set up in 2021–2022.

-> [Read more](#)

Thermal battery TESIS

(Photo by DLR (CC BY-SA 3.0))

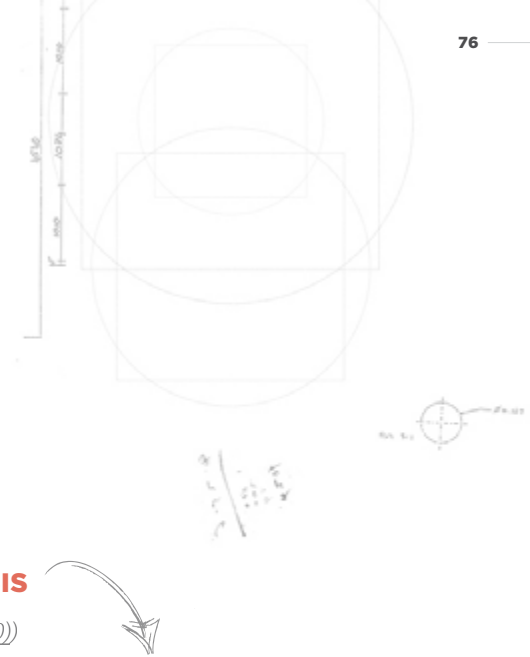

Mechanical energy storage

Pumped hydro

By pumping water vertically into a storage pond for later use, pumped hydro energy storage is a method of converting excess electrical energy into stored energy. From an energy management point of view, these rank among the peak load power plants and, due to their high capacities (up to 3 GW) are among the largest storage options. In general, overall efficiencies of 70–85 per cent can be assumed for pumped storage power plants. In contrast to other forms of storage, either very short or very long storage periods have no influence on the efficiency of the overall system.

The application of pumped hydro energy storage is limited by the demand for suitable geographic locations with a height difference, enough space for the reservoirs, a waterway and supply centres. In many coal regions, natural geographic characteristics will prevent the standard application of pumped hydro energy storage. However, it is worth noting that depending on the vertical scale of prior mining activities, both abandoned open-pit and underground coal mines may be suitable locations for an unconventional hydropower application (see [page 89](#)).

Compressed air

Compressed air energy storage (CAES) plants are largely equivalent to pumped hydropower plants in terms of their applications. But instead of pumping water from a lower to an upper pond during periods of excess power, in a CAES plant, ambient air or another gas is compressed and stored under pressure. Larger-scale applications have been using [underground salt caverns](#), but other locations and technological solutions are currently being explored (e.g., [undersea insulated airbags](#)). When electricity is required, the pressurised air is heated and expanded in an expansion turbine driving a generator for power production.

The technology is considered to be cost competitive today, yet technologically complex. In addition, its applicability is limited due to location restrictions.

Flywheels

A flywheel energy storage system (FESS) is based on a rotating device that contains a spinning mass in its centre which is driven by a motor to store energy – and when the energy is needed, the spinning force drives a device similar to a turbine to produce electricity, slowing the rate of rotation. A

flywheel is especially suitable for capturing energy from intermittent energy sources such as [solar and wind](#) over time and delivers a continuous supply of uninterrupted power to the grid. Flywheels are also able to respond to grid signals instantly, providing opportunities to stabilise grid fluctuations. The technology requires low maintenance and long life-cycles but is not a suitable option for storing high amounts of power from a technical standpoint.

Goldisthal pumped storage plant (Germany)

(Photo by Vattenfall)



Electrochemical battery storage systems

The greatest prospect for electrochemical storage is the stabilisation of frequency and voltage within hourly and daily fluctuations. So far, the most readily available technology is lithium-ion batteries, which have long been used in laptops and mobile phones; sodium sulphur batteries are also increasingly becoming an alternative for station-based applications due to their slightly lower material costs and longer service life. Both methods have high energy densities and power-to-energy ratios. This makes them particularly suitable for short-term storage over minutes or hours. Large battery storage systems can already be set up relatively quickly and cost-effectively today, e.g., the [LEAG 'big battery' project](#) at Schwarze Pumpe power station in Germany. The market prices are below USD 1 million per MW of installed capacity with a storage capacity in the range of several MWh. An important aspect to consider is that electrochemical energy storage systems have typical operation timespans between 10 and 20 years due to limited cycle stability and durability. Given that lithium-ion batteries are also used for electric cars and other mobility solutions, demand for lithium and therefore prices may increase in the future. However, as the [development of technology for chemical batteries has expanded](#), and new advanced technologies such as solid-state batteries and flow batteries are moving towards becoming cost competitive, it can be expected that more applicable solutions will be available in the coming years.

EAG 'big battery' (Schwarze Pumpe power station in Germany)

(Photo by LEAG)



Energy technologies with uncertain prospects

(Fossil) natural gas

Gas-fired power plants are suitable for providing a flexible supply of electricity (similar to the above-described energy storage solutions), a characteristic that will be needed and valued in systems with high shares of wind and solar energy. Gas-fired power plants can also supply heat in the case of combined cycle gas turbines (CCGT). The current global weighted levelised cost of energy from natural gas with CCGT technology averages at 71 USD/MWh. As it is based on natural resource combustion, prices also largely depend on gas prices, supply and demand conditions, and other regional factors such as the geopolitical situation. Generally speaking, gas combustion itself produces almost 45 per cent fewer CO₂ emissions than coal and emits fewer other pollutants (leaving out value chain emissions from transport, etc.). This is why the use of natural gas is often described as a 'bridge technology' on the way to climate neutrality. However, these projections also show a global peak of production of around 150 EJ in 2030 (which equals 2,000 GW of installed electrical capacity) – which is mostly due to the fact that burning natural gas is still producing significant carbon emissions, even if lower than coal.

The IEA NZE scenario in figure 20 calculates that gas production in 2050 will be 55 per cent lower than in 2020 (with the remaining production capacities using CCS technologies), which is still higher than many climate experts would estimate due to new findings regarding methane emissions and economic risks (see box "Environmental implications and economic risks regarding natural gas" on page 80). Taking into account new findings regarding methane emissions along the value chain and the fact that burning natural gas still produces emissions which need to be drastically reduced in the upcoming decade, there is a high risk of producing lock-ins and stranded assets. For this reason, natural gas can only be a short-term option for coal regions in transition in the majority of cases.

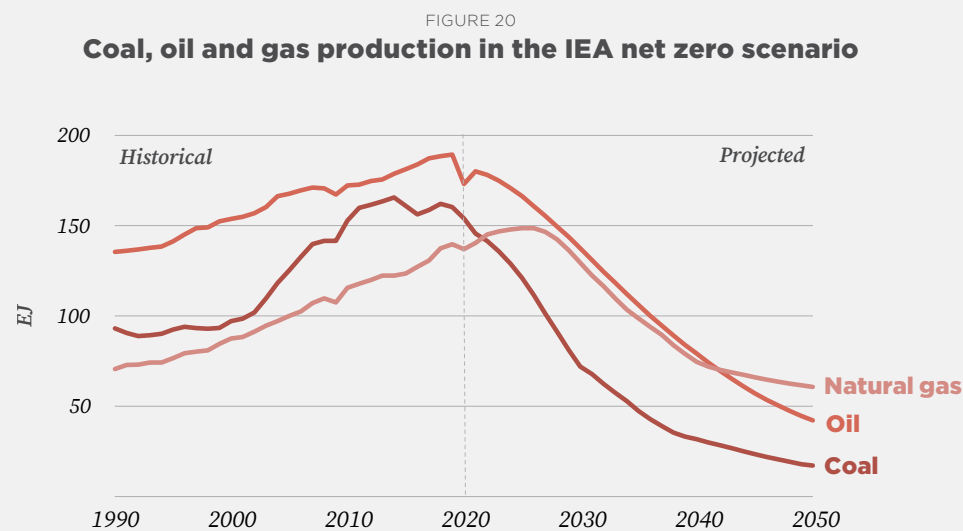

Between 2020 and 2050, demand for coal falls by 90%, oil by 75%, and natural gas by 55%

Source: IEA 2021

Environmental implications and economic risks regarding natural gas

CO₂ reduction potential and alignment with climate targets

In a climate-neutral energy system, there is only very limited space to use natural gas (if any). Consequently, on the way to limiting global warming, climate neutrality can only be achieved with a massive reduction of natural gas within the coming decades. The pace at which this reduction must occur depends on assumptions related to, for example, emissions from other sectors, the availability of cheap storage options which would make high shares of renewables cost-competitive in the nearer future, and the role of carbon capture and storage (CCS). Despite the insecurities stemming from these different assumptions, it is clear that the use of natural gas will need to be reduced drastically in the long-term.

Methane leakage

Methane, the primary component of natural gas, is a relatively potent greenhouse gas with a high global warming potential 87 times that of carbon dioxide (averaged over 20 years); even averaged over 100 years, the impact of methane is still 36 times that of CO₂. The overall emission assessment of using natural gas for energy production mainly relies on the prerequisite that this gas is indeed burned, and that only a very small amount of the highly potent greenhouse gas methane gets lost over the whole product chain. An increasing share of climate research indicates that the methane impacts of fossil fuel extraction have been greatly underestimated by up to 40 per cent, revealing more uncertainties regarding methane emissions. This means that potential climate benefits of using natural gas may be offset by leaks at drilling fields or other stages of natural gas production and transportation. Increased power generation from natural gas therefore remains a risk, because a better understanding of the actual impacts of methane leakages might call into question the greenhouse gas benefits it offers over coal.

Risks of stranded assets and lock ins

The lifespan of new gas-powered power plants is approximately 20 years, while large pipelines, terminals and infrastructure for liquified natural gas (LNG) are designed to run for several decades. Consequently, an increasing number of studies are pointing out the risk that natural gas investments could become stranded assets, given the long lifetime of gas infrastructure projects, as well as the need to phase-down natural gas use in order to meet climate targets. The question of whether investments are still valuable must be given careful consideration, taking into account potential effects for long-term decarbonisation (lock-ins) and the future use of alternative gaseous fuels in the energy mix.

An option which could prolong the use of gas infrastructure is utilising climate-neutral gas from renewable sources like e-gas, biogas and hydrogen. However, it is doubtful that this can be considered as a mid- to long-term alternative for gas power plants, as it will be too expensive to first produce carbon-free gas and then burn it (see next "[Decarbonising energy-intensive industries](#)" on page 96).



Bioenergy

Generally speaking, bioenergy is a versatile energy source that can be used in many sectors according to the potential use in already existing end-user equipment and distribution systems. Technologies using bioenergy by burning wood pellets and creating biofuel from crops such as soy, palm and rapeseed can be considered quite mature and readily available. However, a distinction should be made between the use of bioenergy to produce electricity and other forms of energy uses (biofuels, gases), which often leads to misconceptions about the potential role of both technologies in the future. Generally speaking, the IEA projects a demand of 100 exajoules (EJ) in the NZE scenario for bioenergy, which accounts for about 19 per cent of the calculated global energy supply in 2050. While this sounds a lot, only very little of this is attributed to electricity production: in the NZE scenario, the IEA projects 640 GW as the electrical capacity of bioenergy by 2050, which equals a 2 per cent share in the energy mix of the future. This is mostly due to higher prices: the total levelised cost of biomass power generation technologies are higher overall than coal, but also as wind hydro and solar technologies at rates between USD 86 and 150 per MWh. The high variation in costs is due to production methods and especially feedstock costs. Regardless of the more prominent role bioenergy is expected to play, there is a critical debate about whether biomass should be considered a renewable resource at all, and several sources point out that the amount of biomass needed for energy purposes is extremely high and that sustainable, reliable and cost-effective biomass sources are very limited (see box "[Serious concerns regarding the use of biomass for energy production](#)" on page 82).

Given concerns around environmental sustainability, it is advisable that new policy frameworks be mirrored towards bioenergy. Feedstock limitations call for strategies to secure reliable and efficient feedstock supply chains – a challenge that will prevent the use of biomass for electricity production at larger scale in most regions. In particular, coal regions should check whether there is the potential for projects to convert coal-fired power plants to burn biomass: as for gas plants, the risks of lock-ins and stranded assets are often underestimated.

Wood pellets



Serious concerns regarding the use of biomass for energy production

Biomass materials are often described as ‘climate-neutral’ as they set free the same amount of carbon when burned as they remove from the atmosphere while growing. This assumption has been called into question in light of the use of increasing shares of woody biomass. When wood is burned, the carbon contained in the wood is obviously emitted immediately. But it takes a long time for trees to regrow and extract that same amount of CO₂ from the atmosphere again. It may thus take decades before net climate benefits are realised with a shift from burning coal to burning woody biomass.

Conflicts with biodiversity and soil quality goals

Furthermore, wood as the direct source is not the only aspect that can cause negative environmental effects; the removal of residues (typically branches and tree tops left after felling, as well as stumps and roots) for bioenergy can have negative impacts on soil quality and biodiversity. Assessing different management methods for woody biomass production, a recent [report](#), for instance, states that only one out of 24 studied biomass development pathways (burning of fine woody debris and slash) is actually carbon neutral or positive with respect to both emission reductions and biodiversity.

FIGURE 21
Demand and supply of industrial wood pellets (2017)

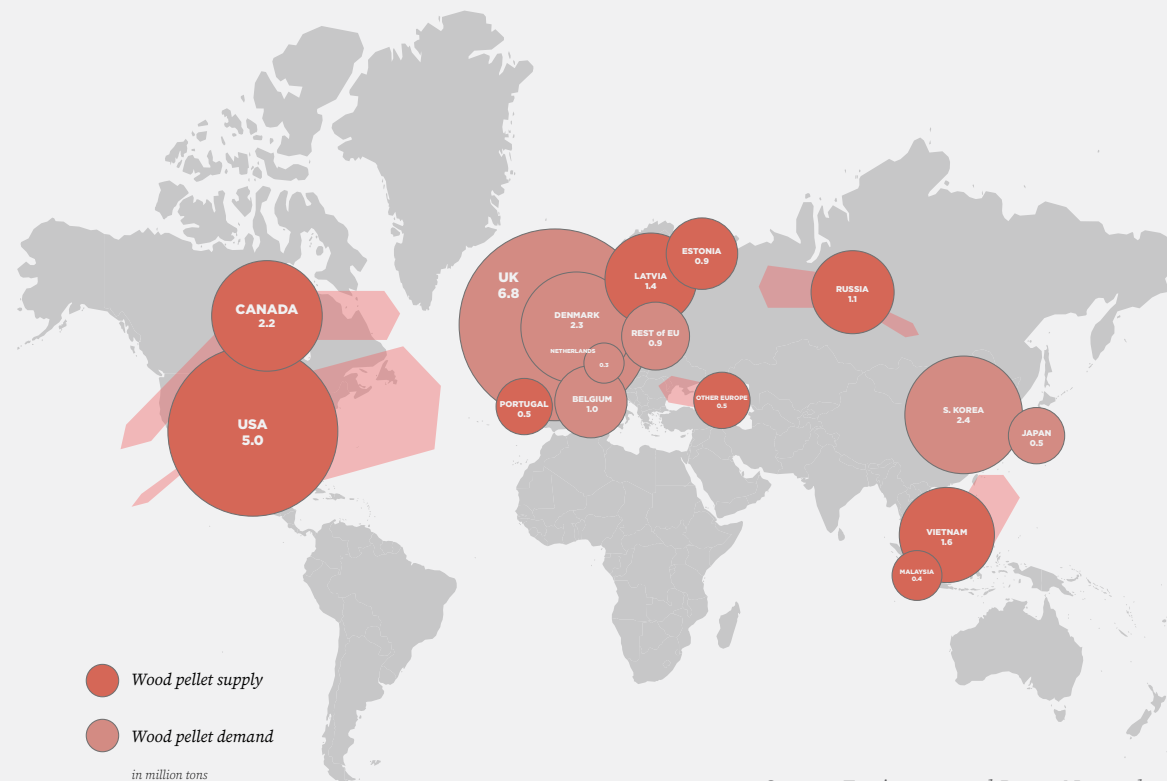

Source: [Environmental Paper Network](#)

Conflicts regarding material use

Biomass feedstock can come from very different sources (wood, agri- and forest residues, municipal solid waste, sewage sludge, food waste, industrial waste, etc.). Depending on the source, concerns have been raised on their environmental sustainability, and on whether these materials should be used for energy at all, or if they would be better used for other purposes such as food, timber or paper.

Conflicts regarding land use

The same concern applies to the land that is needed for large amounts of feedstock: in the past, communities in some regions were affected by land grabbing, as governments were granting land rights to companies for producing biofuels, displacing indigenous farmers without adequate substitutes or reparations.

Scalability is already limited today

As the potential conflicts around bioenergy sources above show, the biggest challenge for bioenergy production is a sustainable feedstock supply. The struggles around feedstock supply are already quite visible today for wood (pellets), which for example can directly replace coal for energy purposes and is today's most common source of biomass. In many countries today, the majority of wood pellets are imported (see [figure 21 on page 82](#)). Large import rates are a symptom of a much bigger issue: the amount of biomass needed for energy purposes is extremely high, and sustainable sources that are reliable, local and cost-effective may be very limited (see 'Ireland's utility struggles to find sustainable biomass sources').

For example, it has been calculated that realising the 67 coal-to-biomass projects that are currently proposed in the EU would triple the amount of biomass burned in current and former coal power plants in the EU. The amount of feedstock needed to fuel these power plants would be 36 million tonnes (MT) of wood pellets, which is the equivalent of the entire current global wood pellet production. To harvest this amount of wood, it would be necessary to cut down approx. 2,700 km² of forests every year. The resulting increase in demand may result in higher feedstock prices and, in the mid-term, also increase deforestation (a trend that can be already seen today), which indicates additional carbon losses that would – as a result – require extra emission reductions in other sectors in order to reach climate neutrality by 2050.

Example: Ireland's utility struggles to find sustainable biomass sources

In County Offaly, Ireland, local utility ESB had planned to switch one peat-fired power plant to using biomass. However, in 2019, the government refused to give permission to this conversion due to biodiversity and climate concerns. This decision was primarily based on the lack of information provided by ESB on the potential sources of biomass, as the company could not reasonably determine that the direct and indirect impacts on the environment would be sufficiently mitigated. The regional authorities stated that a foreseeable 'high dependence' on imported biomass would not be in line with either national or EU climate goals.

Bord na Móna, another Irish company running a co-fired biomass plant, had previously raised public concerns, as it mostly used palm kernel shells from environmentally questionable palm oil monocultures as the source for biomass. Since then, the company has tried to switch to more sustainable sources but acknowledges that reliable, local and cost-effective biomass supply at scale remains a 'significant challenge'.

Hydropower

Hydropower stations produce electricity by using water turbines that are built within flowing water systems (e.g., rivers) or in connection with a dam/water reservoir that can then be emptied through turbines. Hydropower can also be used to store energy (see also [page 75](#)). In 2019, hydropower accounted for approx. [1,300 GW of installed capacity](#) worldwide with the most power stations installed in China, Brazil and the United States. The LCOE of hydropower ranges between USD 46 and 104 per MWh for run-of-river facilities and between USD 39 and 142 per MWh for hydropower based on water reservoirs applications.

Around 1,300 GW of electricity capacity is installed today; according to the IEA, that amount will double by 2050. Compared to other renewable technologies, hydropower is not yet expected to grow in the same way as wind and solar technologies due to several downsides and risks that are linked primarily to dam-based hydropower: while these technologies can provide large amounts of baseload power, their development and operation come with environmental as well as social costs. Studies have shown that dams [disrupt river ecologies](#) to quite a significant extent, including effects such as water quality, aquatic and terrestrial biodiversity. New studies state that [methane emissions](#) released from exposed reservoir soils have been underestimated, which calls into question the overall very low GHG assessments of hydropower at a minimum. On the social side, dam construction may require the displacement of thousands of people, altering people's livelihoods and affecting their access to water and ability to set up agriculture. While there are technical solutions and improvements that can be made for some of these problems, large hydropower dam installations in particular require high initial investments and take a long time to build, which will hinder applicability especially for countries with limited access to

financing. With regard to cost-benefits, there are also doubts as to whether new constructions are actually profitable: an [Oxford study](#) evaluated 245 large dams and found that they were not cost-effective and that their actual costs were nearly double their budgeted costs. Another [study](#) also highlights how the effects of climate change (e.g., due to droughts) significantly limit full-capacity operation. In light of this knowledge, it is crucial to carefully establish whether hydropower is still valuable overall in terms of the economic, social and environmental outcomes. While large-scale dam hydropower stations are at higher risk of becoming stranded assets, smaller run-of-river power plants may represent a better alternative for which suitable risk management measures can be provided in an easier and more affordable manner.

Large hydropower dam installations require high initial investments and take a long time to build, which will hinder applicability especially for countries with limited access to financing

Nuclear energy

In light of the accelerating energy transition debate, nuclear power is being discussed as another option to scale up non-fossil energy production. Nuclear energy does not produce any carbon emissions except during construction and other secondary processes. For this reason, international organizations, private businesses and scientists in some of the countries in which the technology is accessible believe nuclear energy offers some potential in the pursuit of climate neutrality. Its share of global electricity generation is currently about 5 per cent, with a comparably low LCOE of around USD 32 per MWh for long-term operating facilities and USD 52 to 75 per MWh for new power plants. The IEA projects an electricity capacity of 812 GW by 2050, which is around 2 per cent of the total estimated worldwide capacity. But given that experiences with commercial nuclear energy generation over the past seven decades also point to significant risks, there is still an ongoing debate as to whether nuclear energy is actually a viable option for energy production at all and, specifically, whether it can play a role in the transition towards a climate-neutral future. Critics primarily address the following issues:

- **Timely availability:** even if the decision were made to build new nuclear power plants today, the usual timeframe of two decades for planning and construction means that the power plants would be connected to the grid too late to play a significant role in addressing the urgent need of countries and regions to decarbonise their energy systems within the coming years.

- **Safety risks and storage of waste:** first and foremost, catastrophes involving the release of radioactive material are always a real possibility, as illustrated by the major accidents in Chernobyl and Fukushima. Whether due to accidents or terrorist attacks, the consequences of radioactive fallout are in any case so drastic and severe that they need to be avoided at all costs. Additionally, the safe storage of highly radioactive material must be guaranteed for at least one million years, a task which may not even be possible. Given that the risks involved for future generations cannot be authoritatively determined today, heavy burdens will undoubtedly be pushed forwards to the future.
- **Economic viability and efficiency:** nuclear energy has a low LCOE as mentioned above, which suggests that it is a cheap source of energy. Many experts question the veracity of this, however, as investment costs for new power plants have been systematically underestimated and were heavily subsidised in the past, mainly due to largely unknown costs involved in dismantling nuclear power plants and in the safe storage of radioactive waste, which are not adequately included in the calculations for the most part. In Germany, for example, the costs of reactor dismantlement and waste storage have lately been calculated at USD 192 billion by 2099 – while the nuclear operators initially set aside only USD 42 billion as provisions, which highlights the gap between cost expectations and reality.

Overall, when considered in terms of the extent to which an investment in a certain technology creates benefits for the energy transition, nuclear energy can hardly be seen as a driver for such efforts. The technology does come with low emissions but at high risks, which need to be taken into greater account than a look at the LCOE and emissions alone suggests.

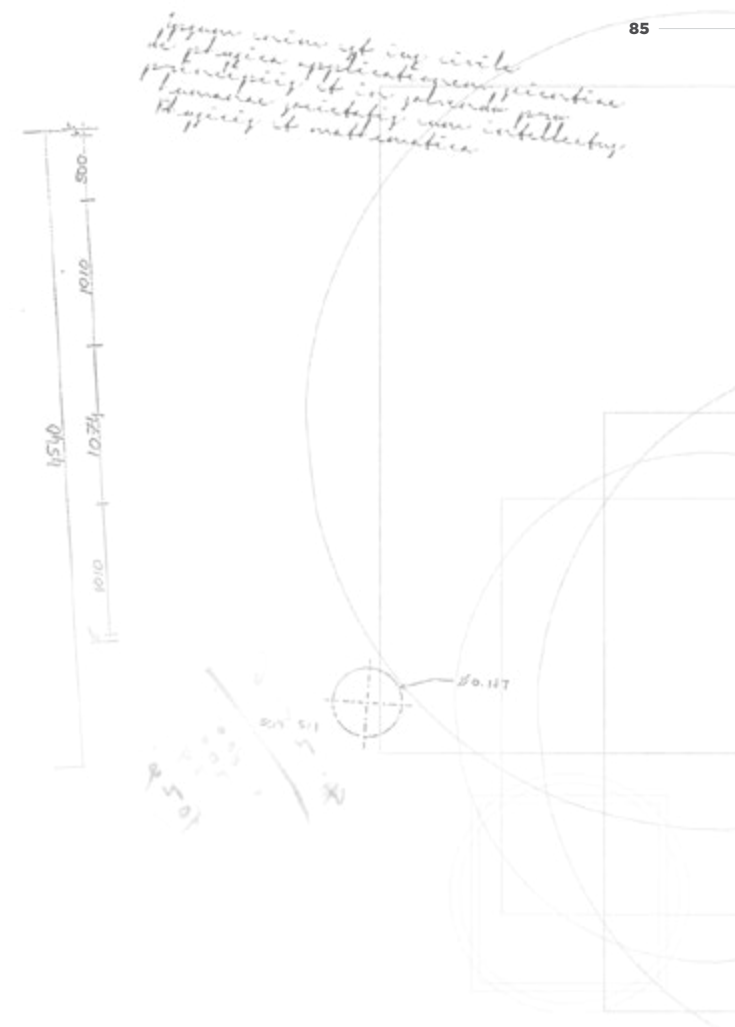

**Nuclear
technology does
come with low
emissions but
at high risks**

Coal-related infrastructure repurposing

Coal regions have always undergone a cycle of prospection, operation and eventual closure, whether due to depleted resources or uneconomic mining and energy production. When these industries close, they can leave behind a legacy of environmental degradation alongside many other challenges. Locations formerly used for mining and related industrial activities require environmental rehabilitation, and the repurposing of land and infrastructure may be necessary to make them available for future use.

Timely and efficient repurposing of land and infrastructure is often seen as a decisive factor in attracting new businesses and permanent new jobs in the region and is key to opening up opportunities for renewed regional prosperity in future. Coal-related infrastructure often has assets (like railway lines, strong electricity grids, access to rivers, and so on), which could offer interesting potential for future uses (such as industry, renewables, etc.).

Challenges and risks

Generally speaking, as every region is different with regards to existing infrastructure, economic specialisation, geology, the workforce and political contexts, each coal region faces different challenges. For this reason, arguments for or against a certain option for the after-use of coal-fired power plants and their related infrastructure must fit into an overall transition strategy for the region first and foremost (see section 1).

The attractiveness of the land and its assets – and thus the potential for repurposing – depend on a number of regional and local factors, such as the site location, sectoral demands, economic opportunities,



etc. In practice, the challenges and risks also vary depending on the type of region (rural or urban), the type of mining (open cast mines or underground) and the predominant assets for which repurposing is sought (land, buildings, other infrastructure, etc.).

Key challenges for the repurposing of open casts and underground mines as well as coal-fired power plants are:

- *For open cast mines:* securing site safety and environmental rehabilitation of large areas (land and lakes) for future uses, including forestry, agriculture, water management, tourism, and renewable energy
- *For underground mines:* securing site safety and environmental rehabilitation of heaps and rivers, ensuring ground stability above post-mine areas and perpetual obligations (e.g., pumping of mine water)
- *For coal-fired power plants:* environmental rehabilitation of contaminated sites, timely and site-specific repurposing of land (especially in urban areas) and reuse of existing infrastructure

These challenges largely relate to the timespan of closure activities. The time available between the present and the (expected) closure of mining and related activities will significantly affect the choices and options available to decision-makers. From an ideal planning and financing perspective, the more time available to adapt, the smoother the transition will be, and the larger the potential to build up the necessary financial incentives and provisions.

From a governance perspective, ***one of the main risks is that coal companies might be unable to fully cover the costs of closures***, leaving a substantial financial burden on society as a whole. These financial risks might be the product of false planning, vested interests

of private companies to maximise profit, but also a consequence of new climate policies that change the preconditions for coal operations. This means that good governance needs to provide a framework that ensures economic, social and environmental risks are reduced and that there are incentives and rules for mining companies to fulfil their obligations.

A good policy framework should:

- Set up rules to secure financing for mine and power station closures.
- Address regional knowledge and capacity gaps and make use of tools and good practices.
- Establish institutional and governance structures to coordinate approaches, speed up implementation and increase acceptance among local and regional populations.
- Reduce overall risks and uncertainties around the regulatory situation.

However, if the financial risks of closure cannot be fully checked, public-sector intervention might be inevitable. This may occur either because companies do not fulfil their obligations or because outcomes of their actions are not aligned with regional development and diversification aims.

In this case, approaches to secure financing for rehabilitation and repurposing include:

- Pooling funds to guarantee the rehabilitation process is implemented.
- Covering long-term costs in run-off companies to guarantee funding of perpetual costs.
- Outsourcing closure planning and implementation at an early stage of mine operation to create financial liabilities and ensure implementation.

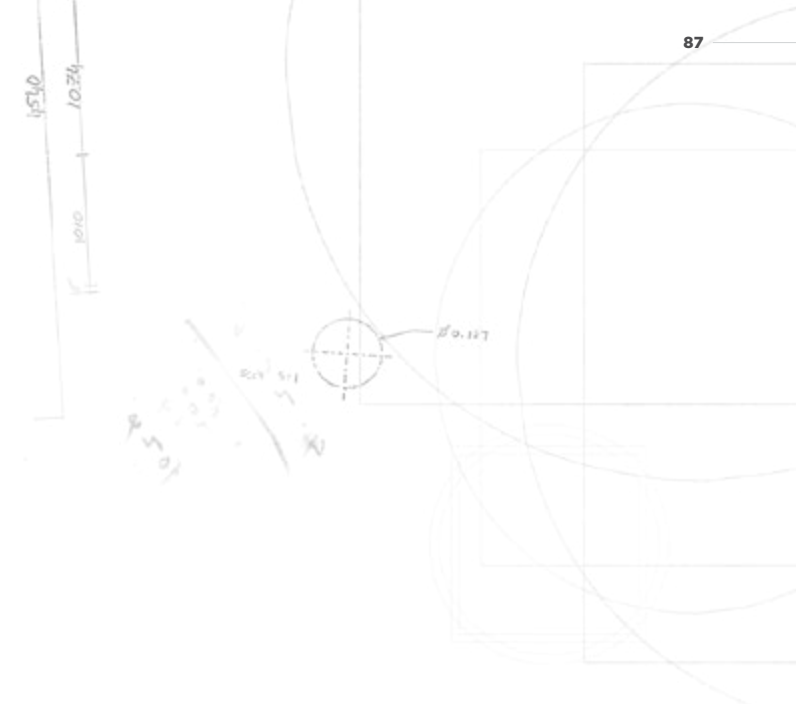

The more time available to adapt, the smoother the transition will be, and the larger the potential to build up the necessary financial incentives and provisions

It is important to note that securing financing is both a challenge and an opportunity. Mine and power station closures can provide the opportunity to better integrate redevelopment, repurposing or conversion plans so they are aligned with public, long-term spatial and economic development interests.

Applying tools and good practice guides can help to bolster knowledge and capacity on environmental rehabilitation and repurposing related to closure processes. Extensive professional guidance is available regarding the closure of mining sites in particular (see box and the [EU Environmental Rehabilitation toolkit](#)).

Enhanced coordination to speed up the implementation as well as acceptance among the local population are preconditions for successful transitions. Institutional and governance approaches can help foster these transitions. These approaches include establishing new public institutions, building strategic partnerships and enforcing long-term regional planning processes.

Guidance for mine closures and repurposing

Mine closure – checklist for governments

The purpose of the checklist is to inform policymakers in the APEC region about key aspects that are required in successful mine closure governance frameworks according to current international guidelines and standards as well as international experience. It is intended to provide a logical, sequential series of actions that enable policymakers to recognise and address any gaps in their current mine closure frameworks.

[-> Read more](#)

International Council on Mining and Metals (2019): Financial concepts for mine closure

The purpose of this document is to arrive at a better understanding of the different types of closure cost estimates associated with mine closures and to establish a consistent understanding and communication within the industry as well as on the part of external stakeholders.

[-> Read more](#)

International Council on Mining and Metals (2019): Integrated mine closure: Good practice guide

The purpose of this guide is to provide members of the ICMM and other responsible mining companies with directives for promoting an approach to integrated decommissioning planning and making best practice more consistent across the sector.

[-> Read more](#)

SRK Consulting/World Bank (2021): Mine Closure: A Toolbox for Governments

The toolbox is geared towards policy makers, governmental administrators and lawmakers with practical guidance and key information to help them develop governance frameworks for a successful mine closure. It includes examples of good international industry practice along with the required basic legislation for mine closure.

[-> Read more](#)

Bainton, Nicholas and Holcombe, Sarah (2018): A critical review of the social aspects of mine closure

Based on an extensive literature review, this paper gives key recommendations on the social aspects of mine closure. In particular, the paper highlights an often-experienced lack of understanding of the real and externalization costs resulting from mine closures, both of which can add to the social costs of mine closure.

[-> Read more](#)

Repurposing options for former coal mining areas

Environmental rehabilitation

Rehabilitation must not be viewed as a liability for coal regions but rather as the key element for forging a new future, as a cleaner environment and good living conditions can offer new business models and are a prerequisite for attracting highly skilled workers to regions. Environmental rehabilitation measures, for instance, have often been a first approach to compensate for job losses in the short term. For example, it has been estimated that environmental rehabilitation measures in the Australian Bowen Basin in Queensland, with its 40 coal mines and 94,600 km³ of land, would create 2,000–3,000 jobs. At one site, the Blair Athol coal mine, estimates project that around [40 full-time jobs for the next 6–10 years](#) could be created. This would be more jobs in environmental rehabilitation measures than previously employed in mining at that site (see also [page 123](#) regarding jobs).

Repurposing for energy production

Floating solar plant at a former mine in Anhui, China

A solar plant with 102 MW and a size of 63 ha was set up in 2017 at the site of a former collapsed and flooded open-pit coal mine. According to the project developer [Sungrow Power](#), installing PV on water has several benefits: due to a cooling effect of the water, the panels can reach higher efficiencies of up to 10 per cent, reduce evaporation of the water, lower cleaning and maintenance costs due to less surrounding dust. Most importantly, underutilised free water surfaces are thus cheap in regions with limited land available. Consequently, these factors can still make floating solar cost competitive despite higher installation costs.

Solar projects at South African coal mines

Eskom, the South African state-owned power utility, signed a deal to collaborate on developing [solar energy projects](#) in its mining sites. By deploying a variety of solar PV facilities, the energy company plans to modernise its energy production system and lower costs as well as carbon emissions by up to 70 per cent. The project will also create jobs and open up reskilling opportunities for communities living and working at and around Eskom operations.

Reuse of mining sites for energy storage

The unconventional use of pumped storage in abandoned underground mines is currently being explored in Poland, Belgium and Germany. This includes assessing geological and geographical conditions, technical and engineering complexity, and the feasibility of construction and operation. Open pit mines are easier to operate in technical terms but offer comparatively lower capacities. The first application of pumped hydro storage in an open-pit mine is currently under construction in an old gold mine in Australia (see example below).

The pumped storage hydro project in Kidson, Australia

The AUD 700 million K2 hydro project is expected to be finalised in 2022 and will utilise two existing mining pits from an abandoned gold mine as the upper and lower reservoirs for a pumped hydro energy storage facility that will have a capacity of 250 MW and can provide up to 2,000 MWh in eight hours. The project is forecasting a contribution of AUD 353 million in net public benefit and will provide 510 jobs during construction and 20 operational jobs.

[-> Read more](#)

Floating solar plant at a former mine in Anhui, China

(Photo by Sungrow)



Transformation to museums, offices and cultural spaces

Many regions come to revalue the old heritage of industrial infrastructure and buildings in later stages of transition, even decades after mines have closed in some cases. New facilities such as recreation centres, museums, science and cultural centres can be developed on the sites, such as has been done in some of the mining regions in Europe, which were already transitioned away from coal decades ago. The [City of Genk](#) is one example in which old, coal-related infrastructure is now strategically used as an asset for modern economic development. This is also the case, for example, in Germany and in Loos-en-Gohelle in France. Both of these sites are now UNESCO World Heritage Sites.

-> **Further reading:** [H2020 TRACER report on good practice cases relating to labour markets, social issues and tourism](#)

Reuse of coal power plants

There is no question that coal-fired power plant sites, including their connections to power grids, water and transportation, as well as the associated skilled workforce, are of significant value for their regions. The connected value chains they create must be taken into account. In light of falling electricity prices offered by renewable competitors and growing pressure on national governments to fulfil their climate obligations to decarbonise the economy, the status quo in coal regions is being increasingly challenged. In addition to the option of demolishing the power plant and possibly reusing the built-in materials (e.g., steel), converting coal plant sites can be a valuable option that reduces decommissioning costs while also reducing the cost of new site uses. In addition to being economically beneficial, the conversion of coal plants can also play an important role for a region's overall transition efforts and preserve its historic identity as an energy region.

Zeche Zollverein (Essen, Germany)

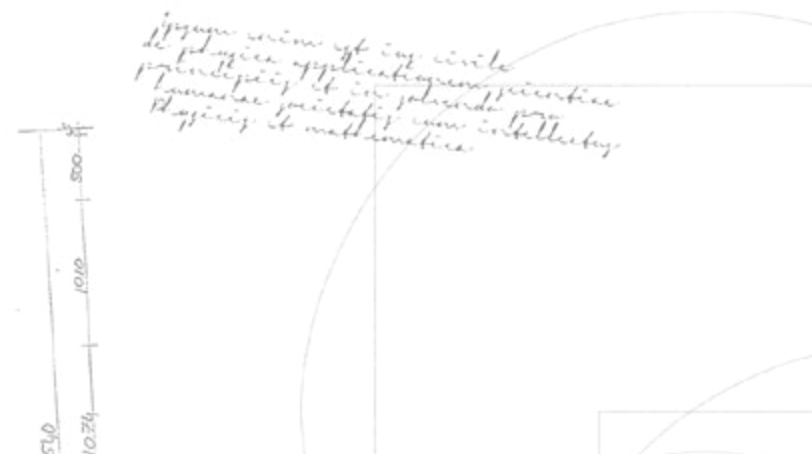

This process includes options to convert power stations to alternative energy facilities such as energy storage, renewable energy hubs, and gas and biomass plants and incorporates examples and ideas for non-energy-related options.

If a region decides to keep the site for energy purposes, a combination of different technologies will be most suitable in many cases, as co-production approaches have the highest efficiency rates. In the case of gas and biomass, special attention needs to be given to limiting factors related to carbon neutrality goals and long-term applicability.

Repurposing for energy production

Wind, solar and geothermal renewable energy

In most cases, coal-fired power plant sites comprise just a few hectares, and both technologies benefit more from their geographic location than from the power plant's technical equipment. However, they should still be considered as an option due to their huge development potential.

Example: Nanticoke Solar Facility, Canada

What was once Ontario's largest power plant facility has now been turned into a solar power farm that generates up to 44 MW of electricity. The new Nanticoke Solar Farm has been able to generate more than 100,000 MWh of electricity to date with a total of 192,431 solar panels installed on an ex-coal yard.

[-> Read more](#)

Sector coupling and clean energy hubs

Initial projects focusing on the future development of coal-fired power plant sites show that a combination of different technologies appears to be a promising approach. Storage technologies can be seen as a viable long-term option for coal plant conversions as they have fewer limitations regarding sustainability than gas and biomass. Moreover, they can make use of the existing grid and power conversion infrastructure and utilise turbines, generators and cooling infrastructure. If geographic conditions allow, nearby areas can be also used for renewable solar, wind and/or geothermal energy production.

Co-generation of electricity and heat should be considered for thermal coal-fired power plants within existing heat networks (primarily the ones close to urban or industrial centres) as this option makes it possible to significantly increase efficiency and reduce overall costs and emissions. Primary options would be thermal storage but also solar thermal and geothermal installations if geographic prerequisites are met.

From a long-term perspective, former coal-fired power plant sites could continue evolving to become clean energy hubs as an element of sector coupling thanks to links between the power sector and industry, transport, and heating and cooling (e.g., by using each other's by-products). A higher degree of efficiency can be reached by pursuing a cluster strategy that combines energy production with demand. This will be one of the key mid- to long-term challenges in the context of energy system decarbonisation (see also following sections on industry decarbonisation and hydrogen). Experts must propose the most suitable energy systems that will be applied in the regions in future.



Initial projects focusing on the future development of coal fired power plant sites show that a combination of different technologies appears to be a promising approach

Example: transforming the lignite-fired Matra Power Plant into part of a renewable energy cluster, Hungary

The Matra Power Plant in Hungary is an example of a coal power plant transitioning towards renewable energy production combined with the integration of an industry cluster. Today, the power plant uses biomass co-firing and a 36 MW PV facility, with plans to add another 20 MW of PV capacity in the near future. In addition to gradually diversifying its energy production portfolio, the Matra Power Plant developed an industrial park nearby that enables companies to use surplus heat and other by-products from the power plant and offers companies the option to become providers of biomass feedstock. The cluster aims to further diversify its portfolio, particularly with the long-term perspective of reducing lignite power production capacity. Different options in line with a decarbonisation strategy are on the table, including a gas-fired combined cycle power plant unit, pumped hydro storage, battery storage, an expansion of the PV facility and a solar panel factory.

[-> Read more](#)

Conversion to natural gas

With energy generation from coal-fired power plants facing increasing pressure, some actors are considering a conversion to natural gas for power plant redevelopment projects. The modifications and replacements required depend significantly on the age of the equipment, access to gas infrastructure and regulations that must be followed. The majority of coal-to-gas conversions that have already been completed tend to be replacements rather than retrofittings.

The primary reasons for a conversion to natural gas are the advantages in terms of technical flexibility for the grid and cost reductions conferred by using existing infrastructure. However, the risk of producing lock-ins and stranded assets is still high, taking into

account new findings regarding methane emissions along the value chain and the fact that burning natural gas still produces emissions which need to be drastically reduced in the upcoming decade (see also [page 80](#)). For this reason, the conversion of coal-fired power plants to natural gas only represents a short-term option in the majority of cases.

Example: coal to combined cycle gas turbine power plant transformation project in Bouchain, France

In Bouchain in northern France, energy company EDF transformed its coal-fired power plant that was shut down in 2015 into a combined cycle gas turbine (CCGT) with a capacity of 606 MW. The company invested a total of USD 450 million into the converted power plant, which started running again in 2016.

Based on modern CHP production, the plant achieves high efficiency rates of 62 per cent. By comparison, efficiencies of coal-fired power plants range between 35–46 per cent. Higher efficiency generally also means fewer CO₂ emissions; however, as stated above, the overall emissions also depend on the climate impacts of the whole production chain. The plant can work as a flexible counterpart in a system with renewables as it accelerates to top capacity in less than 25 minutes and can also be turned down to 30 per cent without major emission drawbacks.

Conversion to biomass

From a technological perspective, using biomass in coal-fired power plants is a fairly simple solution to continue to use power plant sites. A distinction can be made between four general approaches, which differ in terms of the amounts of investments required.

- Co-firing: a share of the coal used in the power plant is replaced by biomass. Depending on the specific technology, the required investments are low, but percentages of biomass in the fuel

Matra Power Plant (Hungary)

(Photo by Civertan (CC BY-SA 4.0))



mix are limited and efficiencies in older power plants cannot compete with the other options.

- Conversion: the coal-fired power plant switches to biomass use as (the predominant) fuel. Boilers and fuel handling technologies will require modifications, leading to significant investment needs.
- Replacement: the coal-fired power plant is fully replaced by a new biomass plant, but existing infrastructure (electricity and possibly heat grids, buildings as well as fuel stock facilities) could still be used. This requires major investment but offers more options in the choice of technology and fuel.
- Relocation and decentralisation: instead of maintaining the site of the original coal-fired power plant, new locations for several smaller biomass CHP systems are set up in the same region, closer to heat consumers. This could increase overall energy efficiency.

In conclusion, it can be said that using biomass in coal-fired power plants requires less changes to the plant itself than the other options mentioned. However, as much as this may appear inviting in individual cases, substituting coal with biomass for power generation purposes is clearly not scalable to all coal regions and coal-fired power plants, and there are serious concerns regarding sustainability and feedstock supply (see [page 82](#)).

Example: Biomass conversion at Drax Power Plant, UK

As one of the largest power plants in Europe and the biggest plant in the UK, the 3.9 GW coal-fired Drax power plant was converted to [co-fire with biomass \(2.6 GW\)](#) between 2010 and 2014. The three-unit conversion cost over GBP 700 million including the associated infrastructure such as on-site wood storage and processing facilities, as well as pelleting and export facilities in the US. The power plant uses approx. two million tonnes of biomass annually, 83 per cent of which is imported from the US and Canada. In 2021, the plant will fully stop using coal. According to plans, the two remaining coal boilers will instead be replaced by combined cycle gas turbines (running with natural gas) and additional battery storage. In the long term, the company aims to add additional carbon capture storage applications; the [first pilot](#) started running in 2019.

Energy storage conversions

Retrofitting coal-fired power plants into energy storages can be considered a viable option for the future use of coal sites, as such a transformation largely benefits from reduced costs for infrastructure. Only the boiler, coal- and flue-gas cleaning and handling systems need to be discarded. Other components, such as steam turbines, generators, condensing heat exchangers and water treatment equipment plants, as well as high value components for switching, transforming and transmitting high voltage power can be reused in their original forms and positions (figure 22). The costs of such transformation can be estimated at around USD 23–27/MWh, which also covers the instalment of heaters, storage and steam generators.

Retrofitting coal fired power plants into energy storages can be considered a viable option for the future use of coal sites

Energy storage plant conversion based on molten salts, Chile

In order to reach climate neutrality by 2050, Chile announced plans to phase out the operation of all coal-fired power plants. Several options are being considered to repurpose these power plants, one of which is converting them into net-zero emission heat storage units (Carnot batteries) by replacing the fossil fuel boiler with molten salt ponds. A 110 MWe molten salt storage system is now being commissioned at the CSP project 'Cerro Dominador' in Maria Elena in the Atacama desert in Chile. The expected calculated cost of retrofitting the 250 MW coal plant into a modern molten salt storage system ranges from USD 300–450 million. The plant operates with a discharge period of 12–14 hours and is expected to reach 38 per cent efficiency, which results in a levelised cost of below USD 90 per MWh. Based on such conversions, existing coal plants in Chile are expected to become net-zero emissions power producers while conserving most of their power plant jobs.

Energy storage based on lithium-ion batteries, Australia

EnergyAustralia has announced plans to build the first four-hour utility-scale battery with a 350 MW capacity. The lithium-ion battery storage system will be located at the Yallourn coal-fired power station in the Latrobe valley, Australia, which will retire in 2032 at the latest. The project is designed to support the economic development of the Gippsland region, helping to secure Victoria's energy supply and enabling more renewables to enter the system.

→ [Read more](#)

FIGURE 22
Integration of molten salt energy storage in existing coal power plants – schematic figure

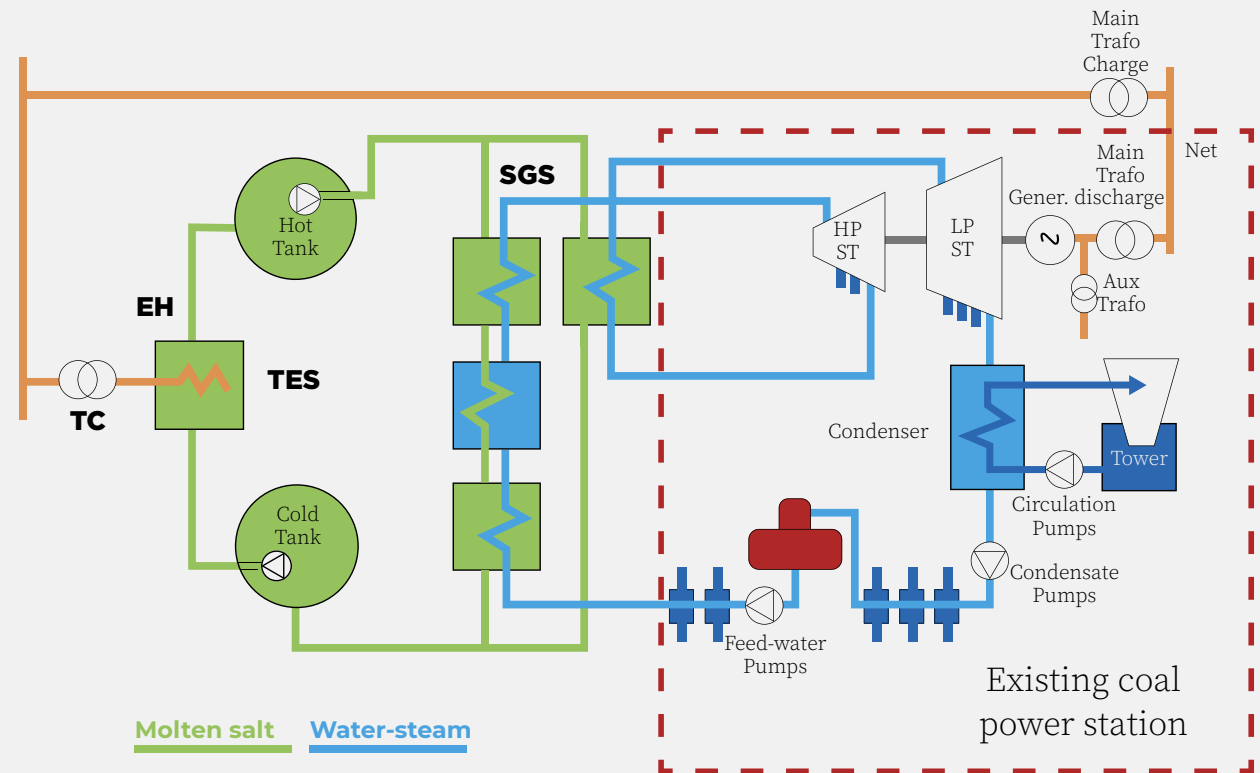

Non-energy uses of coal-fired power plant infrastructure

Besides using coal-fired power plants as sites for energy production or storage, they can also be used for non-energy uses. This is most likely to be the case when certain valuable geographic conditions make non-energy options more feasible, such as locations in urban environments. The decommissioning of power plant sites can be a step towards a climate-neutral economy if the materials from the scrapped infrastructure are used, for example, for secondary steelmaking (small boilers can yield 650 tonnes of steel). The following examples provide an overview of this potential.

Manufacturing of microgrid energy systems

South African electricity utility Eskom plans to completely retire its 1 GW Komati Power station in Mpumalanga, South Africa, by October 2022. Part of the coal plant will be reused to manufacture containerised microgrid systems. These microgrid systems can be deployed to regions where grid-based electricity is too expensive. Among other benefits, the project should help to accelerate South Africa's transition away from coal and provide new jobs in the new renewable energy industry.

[-> Read more](#)

Conversion of coal-fired power plants into data centres

Google transformed the former coal-fired power plant in Widows Creek, US, into a data centre, transforming a former energy producer into an energy-intensive consumer. Data centres require a great deal of energy, accounting for approximately 1 per cent (or 205 TWh) of global electricity use in 2018. Transforming the coal plant into a data centre enables the use of some of the site's infrastructure such as electric transmission

lines, buildings and cooling facilities but also provides opportunities for sector coupling via the potential usage of the by-product waste heat. According to Google, the USD 600 million project in Widows Creek created up to 100 permanent jobs. Similar projects have been realised in Chicago and are at the planning stage in Lansing and Somerset in the US.

[-> Read more](#)

Logistical port for offshore wind

The former 1.6 GW coal-fired power plant in Brayton Point, Massachusetts, closed in 2017 and has now been transformed into a logistical port for offshore wind in combination with an offshore-grid connection, a 400 MW battery storage system and a solar PV system. The USD 650 million project takes advantage of the location, including a deep-water port capable of berthing large trans-Atlantic vessels.

[-> Read more](#)

Redevelopment as offices, student union centre, cultural sites

In urban areas, power plants are predominantly used for purposes other than energy generation after their closure. The potential value of these properties (due to high land prices) often offsets the costs of decommissioning. A broader range of alternatives can therefore be considered, and there are several projects around the globe that offer some possibilities. In Beloit, USA, the city's former coal-power plant has been transformed and expanded into a [student union centre](#) for the neighbouring college, including sports facilities, a library and offices. In Helsinki, Finland, there are proposals to transform the [Hansaari power plant](#), which will close down in 2024, into an arts and cultural centre. In Perth, Australia, the [East Perth Power Station](#) is being converted to serve a mix of residential, commercial, recreational and tourism purposes.

Further resources

IEA (2021): ETP Clean Energy Technology Guide

The ETP Clean Energy Technology Guide is an interactive website with an overview of more than 400 individual technology designs and components that aims to make a contribution towards reaching the goal of climate neutrality. The guide provides information for each technology regarding the level of maturity, plans for development and deployment, targets for cost and performance enhancements as well as current developers of these technologies.

[-> Read more](#)

IRENA (2020): Global Renewables Outlook. Energy Transformation 2050

The Global Renewables Outlook provides another overview of pathways towards a sustainable future energy system. The report highlights technology options with a focus on investment potentials, challenges faced by different regions as well as the policy framework needed for the transition. The key findings are also available in Arabic, Chinese, French, German, Japanese, Russian and Spanish.

[-> Read more](#)

4

Decarbonising
**energy-intensive
industries**

*Ipsum enim et in civile
de physica experimentum scientiae
principis et in solvendo pro
Lymetac scientia non intellectus
Logica et mathematica*

$$\frac{120}{(E_{in}) \cdot \frac{10}{8}}$$
$$(E_{out}) = \frac{96}{8}$$



*Facit enim ingenium primario
partes investigandi etiam non primario
unifera in quibus numerus
et ab inter 100 et 120*

$$\frac{100}{5.5} = 18.18$$



KEY MESSAGES

Energy-intensive industries such as steel, cement, chemical and manufacturing account for about 25 per cent of total CO₂ emissions globally and therefore play a crucial part in the transition.

With many blast furnaces nearing their end of life by 2030, there is a significant window of opportunity for steel industries to invest in climate-neutral technologies.

The key challenges involved in decarbonising energy-intensive industries are long investment cycles, a lack of mature climate-neutral technologies for some processes and unsolved questions regarding infrastructure and policy support.

Given that many energy-intensive production facilities rely on public decisions regarding infrastructure (e.g., hydrogen), there is a strong need for cooperation between industry, politics and stakeholders to identify solutions that will end the 'deadlock' between what appears to be only second-best options.

Potential policy measures to decarbonise energy-intensive industries are carbon contracts for difference, green steel standards, green public procurement, and direct support instruments for hydrogen and its infrastructure.

The role of energy-intensive industries for the transition

Many energy-intensive industries such as steel, cement and chemicals are often present in coal regions across the globe. This is because these types of industries were attracted by the availability of coal as an abundant local energy source. In highly industrialised coal regions, the economic significance and employment rates in energy-intensive industries sometimes surpass that of coal mining – and given that energy-intensive industries such as steel, cement, chemical and manufacturing account for about 25 per cent of total CO₂ emissions globally, the drive to massively reduce greenhouse gas emissions in the sector has increased in recent years. Coal regions with energy-intensive industries are therefore facing a double transformation: the phase-out of coal and the transition to a carbon-neutral industrial base.

Challenges and opportunities

One key challenge in this transition is the long investment cycles in many energy-intensive industries. A blast furnace for steel production has a technical lifetime of about 50 years; key technologies such as a steam cracker in the chemical industry or cement kilns have even longer lifetimes. This means that key infrastructure in energy-intensive industries that is to be built from now on will still be in use in 2050 if stranded assets are to be avoided. According to the world's climate-neutrality targets, investments in those industries need to be in line with a climate mitigation plan which allows for zero emissions by mid-century.

Climate-neutral technologies are in the development phase in the steel and cement industries and are not fully available yet. This means that companies in these sectors might not invest in new capacities



out of the fear of having stranded assets in future. Moreover, climate-neutral technologies are unlikely to be economically competitive once they do become available unless they are heavily subsidised or the carbon price increases significantly. These challenges could lead to a further decline in regional steel and cement industries with negative impacts on jobs in carbon-intensive regions, which would be a doomsday scenario for the affected coal regions.

However, this transition process offers some opportunities. The need to decarbonise energy-intensive industries could spark innovation and attract large investments into the regions. Companies can improve their competitiveness by offering innovative products such as green steel and green cement, which will be a necessary backbone in the transition to a climate-neutral economy.

Due to i) the large investments necessary, ii) the immaturity of key technologies and iii) the necessity of accompanying infrastructure development, this transition will not be manageable by the private sector alone but will need support from and collaboration with the public authorities. However, it is important that regional decision-makers in coal regions have a good overview of the different technology options available for a climate-neutral, energy-intensive industrial sector.

In terms of energy-intensive industries, the steel industry is most closely linked to the coal industry. With that in mind, this section takes a closer look at the steel sector and its technology options.

FIGURE 23
Process and energy-related emissions from heavy industry sectors

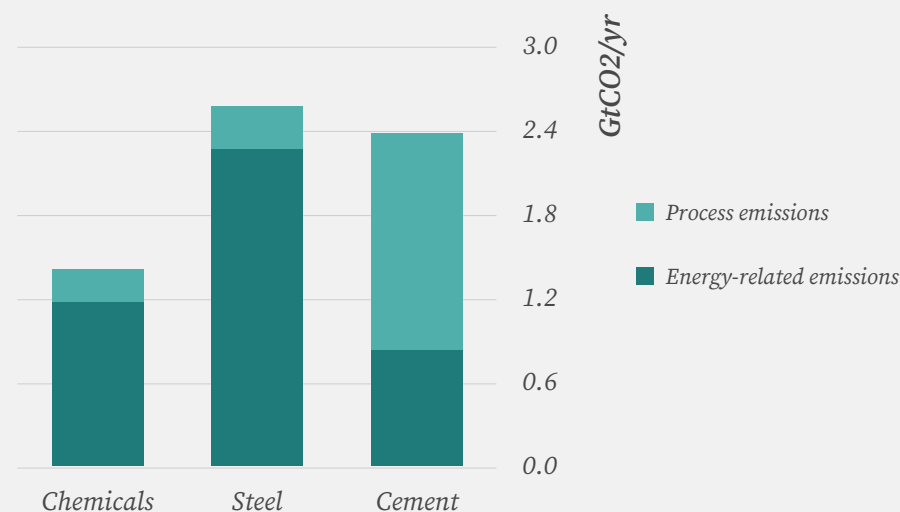

Source: IEA

Emissions From Heavy Industry Are 'Hard To Abate' (As Of Yet)

Climate-neutral production of steel, cement and chemicals will not be achieved with conventional production techniques. One reason for this is that the potential for further energy efficiency improvements is very limited. For example, in steel production, incremental efficiency improvements can only further reduce emissions by about 10 per cent. The second reason is that in addition to energy-related CO₂ emissions, the production of steel, cement and some chemicals also creates so-called process emissions. For example, primary steel production via the currently dominant blast furnace route is dependent on the use of (today mostly coal-based) coke as a reducing agent, which results in process emissions (in addition to energy-related emissions). These process emissions cannot be avoided by simply switching the energy source in existing production processes. Thus, achieving climate-neutral heavy industry by 2050 is only possible based on new technologies and production processes.

Technology options to decarbonise steel production

The steel sector is currently the largest industrial consumer of coal. As such, steelmaking is highly CO₂-intensive: approximately 7–8 per cent of global emissions are caused by steel production. As for the energy sector, decarbonising the steel industry is therefore crucial to put the world on a pathway that is compatible with limiting global warming to 1.5°C. According to the IEA, to achieve net zero by 2050, steel sector emissions need to fall by at least 50 per cent by 2030 and 95 per cent by 2050. Investments in new technologies are necessary in order to achieve this goal. These types of low carbon technologies have developed rapidly in recent years and are now ready to be applied.

It must be emphasised that timing is crucial for all new developments in the steel sector: Assessments by Agora Industry found that around 71 per cent of global coal-based steel blast furnace capacities will reach the end of their operating lifetimes before 2030. Given that investment cycles for steel production facilities are about 50 years, the industry will already arrive at a crossroads in the next few years. Consequently, each reinvestment decision will be between two options: one the one side, companies can choose to invest again in coal-based steelmaking, which appears to be reasonable from today's perspective but will very likely bear the risks of carbon lock-ins, putting jobs at risk and making any pathway compatible with the 1.5°C target unrealistic (see figure 24). On the other side, reinvestments can be streamlined into the implementation of low-carbon technologies that are compatible with climate neutrality pathways but are not fully economically competitive against coal-based steel production without supporting policy instruments. This highlights the need for cooperation

FIGURE 24
Technical lifetime of primary production plants in the steel, chemical and cement sectors with reinvestment in 2025

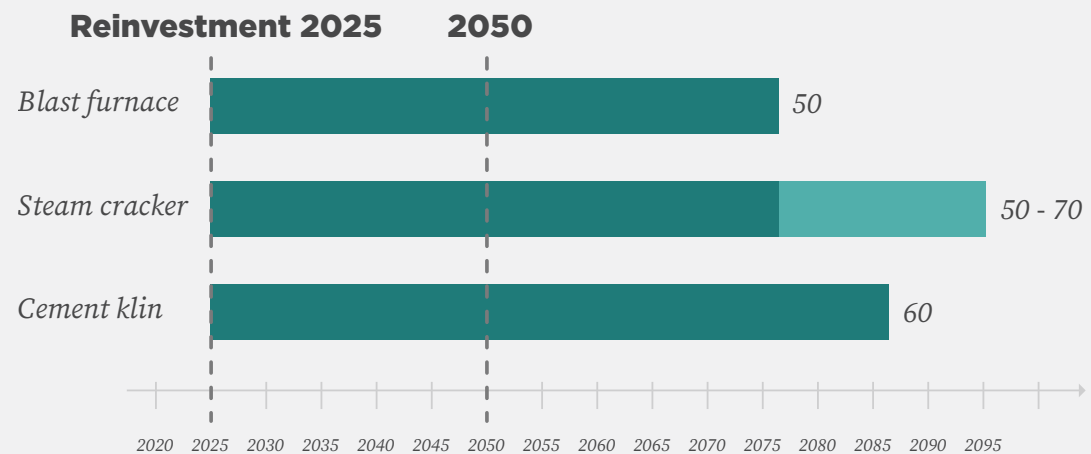

Source: Agora Energiewende and Wuppertal Institute

between industry, politics and stakeholders to identify solutions that will end the ‘deadlock’ between what appears to be two second-best options. This could include carbon contracts for difference, green steel standards, green public procurement as well as support instruments for hydrogen and its infrastructure (see also next section).

Key technologies for steel decarbonisation

Generally speaking, a distinction can be made between two routes via which the bulk of steel is produced:

- Primary steelmaking: the blast furnace in which iron ore is converted to pig iron using coal and then converted to steel.
- Secondary steelmaking: the remaining steel is mainly produced by recycling scrap in an electric arc furnace.

Projections foresee that demand for steel in 2050 will be approximately the same as it is today, with higher shares of recycled steel. In terms of the technology, reducing CO₂ emissions in the secondary steelmaking route is fairly easy, as the melting of scrap is done using electricity and can require the provision of zero-carbon electricity. The greater challenge is decarbonising primary steelmaking processes, which requires the development of new technologies, massive investments in new production facilities and, depending on the technology, large amounts of (clean) hydrogen as a feedstock.

Research is currently focusing on three technological processes for the production of CO₂-free or low-CO₂ steel, which are discussed in the following.

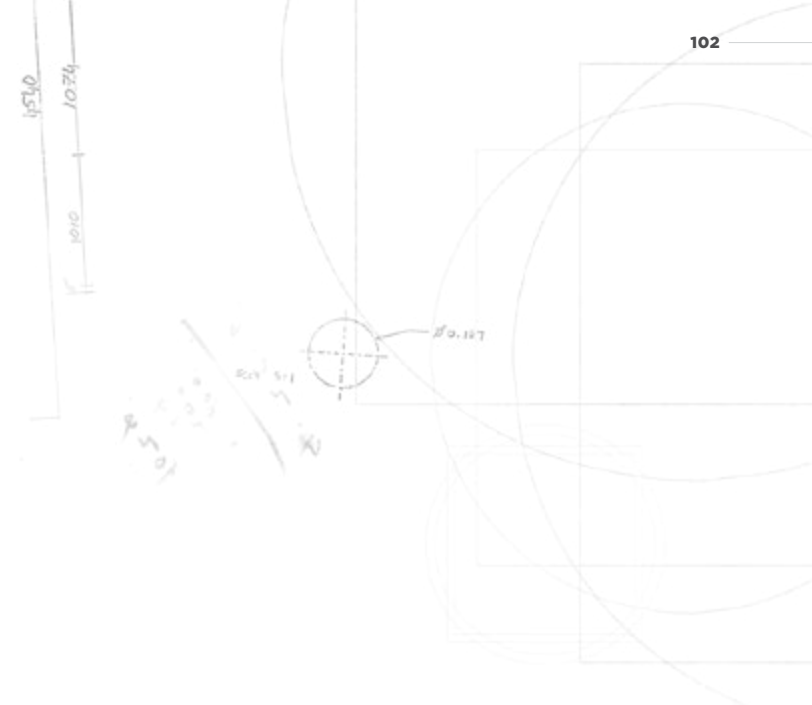
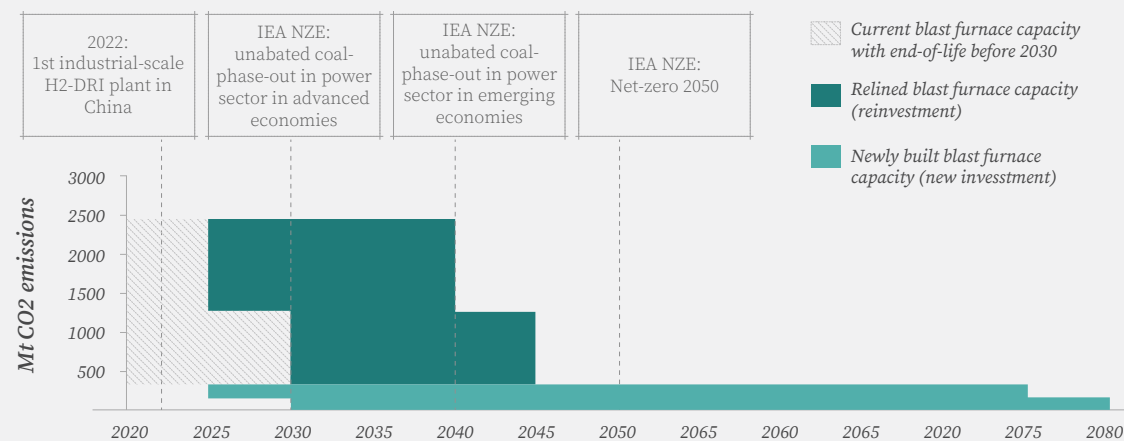

FIGURE 25

Continued investment in coal-based blast furnaces produces a carbon lock-in



Source: Agora Industry 2021

Direct reduction with green hydrogen and smelting in the electric arc furnace (H-DRI)

Technology description

In the direct reduction with hydrogen, iron ore is reduced with hydrogen rather than coke. As a result, there are no process-related CO₂ emissions. The resulting sponge iron is then melted in an electric arc furnace (together with scrap, if necessary) to produce crude steel. This technology option reduces CO₂ emissions thanks to the switch to greener energy sources. It builds on the existing process of direct reduction with natural gas (DRI).

Development stage today and expected application maturity

This technology is currently in the pilot and demonstration phase, and it is expected to be ready by 2025–2030. In principle, it is also possible to start with natural gas and increasing proportions of hydrogen.

CO₂ reduction potential and alignment with EU climate targets

If renewable electricity is used by the hydrogen plant and by the electric arc furnace (which further processes the sponge iron to crude steel) this technology option is almost CO₂-neutral, reducing emissions by up to 97 per cent compared to the integrated blast furnace route. Since the technology can be ready for the market before 2030, it also enables significant CO₂ reductions at a comparatively early stage.

Production costs

The future production costs of hydrogen direct reduction depend heavily on the hydrogen production costs, which in turn depend on the electricity costs, among other things. Experts assume that the cost for a tonne of crude steel produced by hydrogen direct reduction could be USD 600 to USD 700 in 2050. This would be an increase of 36–61 per cent over the current costs of producing one tonne of crude steel in the integrated blast furnace route. Due to an increasing CO₂ price, however, the costs of the latter will also rise considerably by 2050. Hydrogen direct reduction is expected to be cost-competitive from a CO₂ price of approx. USD 110 per tonne of CO₂ (projected for 2030).

TABLE 2

Overview of primary green steel technology options

Technology option	CO ₂ reduction potential <i>(compared to conventional blast furnace route)</i>	Expected application maturity	CO ₂ abatement costs	Key features
<i>Direct reduction with hydrogen and smelting in an electric arc furnace (H-DRI)</i>	-97%	2025-2030	2030: 100-165 €/t CO ₂ 2050: 85-140 €/t CO ₂	requires H ₂
<i>Alcaline iron electrolysis (Electrowinning)</i>	-87%	Only after 2050	2050: 170-290 €/t CO ₂	Requires solely renewable electricity and is more energy-efficient than the other technologies
<i>CO₂ capture and utilisation (CCU) of waste gases from integrated blast furnaces</i>	-50%	2025-2030	2030: 230-440 €/t CO ₂ 2050: 180-380 €/t CO ₂	Does not avoid the generation of CO ₂ itself, but only its direct emission into the air.

Renewable energy and infrastructure needs

The H-DRI technology requires the development of large-scale hydrogen production and large amounts of renewable electricity to produce CO₂-free hydrogen (about 3.3 MWh/t crude steel). This is around ten times as much as for conventional primary steel production in the blast furnace. In principle, regions with low potential to produce renewable electricity could also consider importing hydrogen instead of producing it themselves.

Potentials and limitations

Of the technologies currently being researched for climate-neutral steel production, direct reduction with hydrogen appears to be very promising. It achieves the highest CO₂ reduction, is in an advanced stage of development and generates lower additional costs compared to conventional steel production than other green steel technologies.

Example: HYBRIT project, Sweden

HYBRIT is a joint venture between Swedish companies SSAB (steel), LKAB (mining) and Vattenfall (energy). This project is looking at how to replace coal with hydrogen in the steelmaking process. A pilot plant in Lulea (northeast Sweden) with a capacity of 10,000 tonnes of crude steel a year was put into operation for this purpose in 2020. The hydrogen required for this is produced directly on-site, mainly using renewable energy electricity provided by wind and water. There are plans to construct a demonstration plant with a capacity of over 1 million tonnes of iron by 2025 in order to scale up the processes at an industrial scale. The project aims to achieve a fossil-free steel value chain in 2026.

The total cost for the pilot phase is about SEK 1.4 billion (EUR 136 million). The Swedish Energy Agency contributed more than SEK 500 million (EUR 49 million).

→ [Read more](#)

Example: ENERGIIRON hydrogen-based DRI, China

This technology was developed by an Italian-based Technint Group company together with Chinese steelmaker HBIS to process steel with low carbon emissions using a hydrogen direct reduction system. The plant will be the world's first DRI production plant that is powered by a gas mix-up using a hydrogen concentration of 70 per cent. The steel plant is expected to produce 0.25 t of CO₂ per tonne of steel, which could be further halved using CCUS technologies. The plant will begin production by the end of 2021.

→ [Read more](#)

Alkaline iron electrolysis (electrowinning)

Technology description

In alkaline iron electrolysis, iron ores are reduced to pig iron in a sodium hydroxide solution and then melted to crude steel in an electric arc furnace. By producing iron directly in an electrolytic process, a carbonaceous reducing agent can be avoided. This means that similar to direct reduction with hydrogen, no process-related CO₂ emissions are produced. However, this technology option has yet to be demonstrated at full scale.

Development stage today and expected application maturity

The technology is still in the early stages of research and large-scale use is not expected until after 2050. Currently, a pilot plant in France is under construction ([SIDERWIN](#)) and a demonstration plant in Boston is in the planning stage ([Boston Metal](#)).

CO₂ reduction potential and alignment with EU climate targets

Electrowinning could be largely CO₂-neutral if the full process uses only electricity from renewable energy. This technology is expected to reduce CO₂ emissions by up to 87 per cent compared to the conventional integrated blast furnace route. However, as this technology is not expected to be ready for the market until after 2050, it may not help to achieve the EU goal of climate-neutrality by 2050.

Production costs

The electrowinning process is in the early stages of research, and a cost forecast is uncertain. Experts assume that the specific costs for a tonne of crude steel produced by electrowinning will be USD 720 to 950 in 2050. This would be an increase of 65–112 per cent compared to the same tonne by the integrated blast furnace route and significantly more than by the H-DRI process. Electrowinning is expected to be cost-competitive from a CO₂ price of approx. USD 190 to 320 per tonne of CO₂ (forecast for 2050, since the technology is not expected to be ready before). In general, the future costs involved in the process depend significantly on future electricity costs.

Renewable energy and infrastructure needs

This technology requires large quantities of renewable electricity of about 2.5 MWh per tonne of crude steel. This is around seven times as much as for conventional primary steel production in the blast furnace. However, the electrowinning process is more energy-efficient than other processes for producing green steel, such as H-DRI or CCU.

Potentials and limitations

Electrowinning has the potential to be a promising technology option for green steel production. It has a high CO₂ reduction potential (though not quite as high as H-DRI), it avoids CO₂ emissions during the production process (unlike CCU), it does not require hydrogen and it is significantly more energy-efficient than other green steel technologies. However, its completion might come too late to meet the transformation of the steel industry in line with the EU climate goals. Nevertheless, because of its comparatively lower energy requirements, it is worth keeping an eye on how this technology develops in future.

Example: SIDERWIN

In Europe, the electrowinning process is currently being explored in the Siderwin project. In Maizières-lès-Metz (northern France), a consortium of eleven companies and research institutes led by steel company ArcelorMittal developed an electrolytic cell prototype to reduce iron oxide to pig iron by electrowinning, proving the viability of iron electrolysis. A 3-metre industrial electrolytic cell is currently under construction. In addition to developing and testing a prototype electrolytic cell, the project is researching the extent to which the process can be coupled with the use of renewable energies through flexible operation and integration into the power

grid. Furthermore, the project will test various types of iron ore sources including waste sources as input materials to the electrolysis process. The project is receiving funding of USD 7.8 million from the EU Horizon 2020 programme and runs from 2017 to 2022.

[-> Read more](#)

CO₂ capture and utilisation (CCU) of waste gases from integrated blast furnaces

Technology description

The process of CO₂ capture and utilization (CCU) captures some of the waste that gases produced in steel production in a conventional blast furnace instead of burning and emitting them into the air. The captured waste gases can then be used by the chemical industry as feedstock instead of crude oil. For this purpose, however, the waste gases must first be processed into basic materials such as methanol, which requires additional green hydrogen.

Development stage today and expected application maturity

The CCU technology for steel is currently being explored in two European pilot plants (Carbon2Chem® in Germany and Steelanol in Belgium). Another one is in the planning stage (Carbon4Pur in France). As all individual components of the Carbon2Chem® pilot plant are already market-ready, it is expected that the technology will be ready for large-scale use between 2025 and 2030.



Handwritten notes:
 1000-2
 10000
 100-100

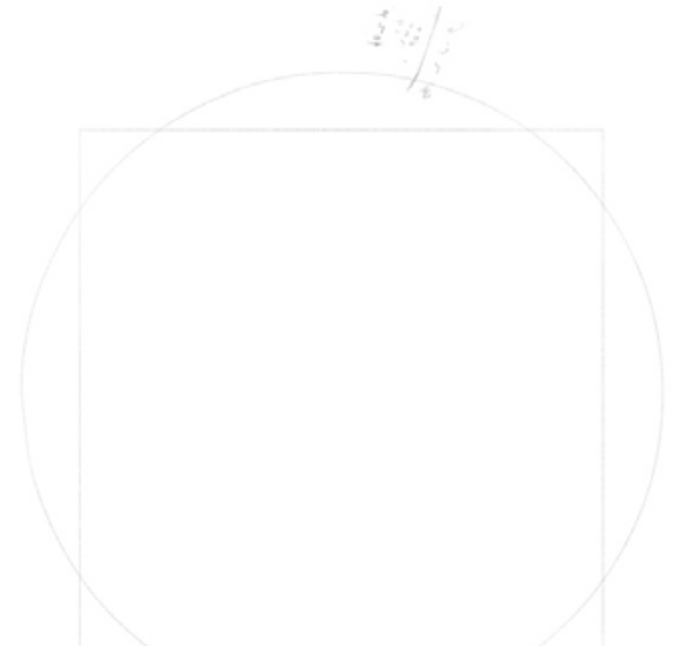

CO₂ reduction potential and alignment with EU climate targets

The CO₂ reduction potential of CCU is very limited. Firstly, CCU only reduces CO₂ emissions by 50 to a maximum of 65 per cent compared to a conventional blast furnace because only part of the CO₂ produced in the blast furnace can be captured¹. Secondly, the actual CO₂ reduction depends on whether the carbon is released again at the end-of-life of the resulting chemical products, since CCU – in contrast to H-DRI and electrowinning – does not prevent the generation of CO₂ itself but only its immediate emission into the air.

For these reasons, the use of CCU is not sufficient for climate-neutral steel production in line with the EU climate targets.

Production costs

CCU is a comparatively expensive CO₂ reduction option for steel production. Production costs are significantly influenced by the cost of hydrogen since hydrogen is needed for the necessary further processing of the separated waste gases into basic materials usable for the chemical industry. The specific costs per tonne of crude steel produced by CCU (including the costs of the further processing of the waste gases) are estimated to be USD 720 to USD 968 in 2030. This would be an increase of 63–119 per cent over the current costs of producing it in the integrated blast furnace route, and much more than the estimated costs for the H-DRI process. CCU is expected to be cost-competitive from a CO₂ price of approx. USD 260 to USD 500 per tonne of CO₂ (indication for 2030).

Renewable energy and infrastructure needs

With 3.6 MWh per tonne of crude steel, the electricity demand for CCU is higher than that for H-DRI (3.3 MWh/t) and for electrowinning (2.5 MWh/t). The higher electricity demand is mainly due to the processing of waste gases into valuable chemical substances. For these processes, hydrogen and the development of hydrogen production and/or hydrogen infrastructure are needed.

Potentials and limitations

At first glance, CCU in the blast furnace route seems to be a relatively easy solution for steel production as it is expected to be ready for use within the next 5 to 10 years and does not require a new production process given that it can be retrofitted to existing blast furnaces. Nevertheless, these processes are very limited.

Firstly, the CO₂ reduction potential of CCU is too low to achieve climate-neutral steel production in line with the EU climate targets.

Secondly, it is uncertain how valuable the use of waste CO₂ from blast furnaces will be for the chemical industry in the future. In the course of its transformation to climate neutrality, this industry will increasingly use non-fossil feedstock. Today, the total industry carbon emissions far surpass the carbon that can be recycled back into the industry. Since this technology uses coking coal as a fuel and reducing agent (unlike H-DRI and electrowinning), it only reduces part of the CO₂ emissions but not other harmful emissions (like mercury, sulphur dioxide and nitrogen) that are caused by burning coal.

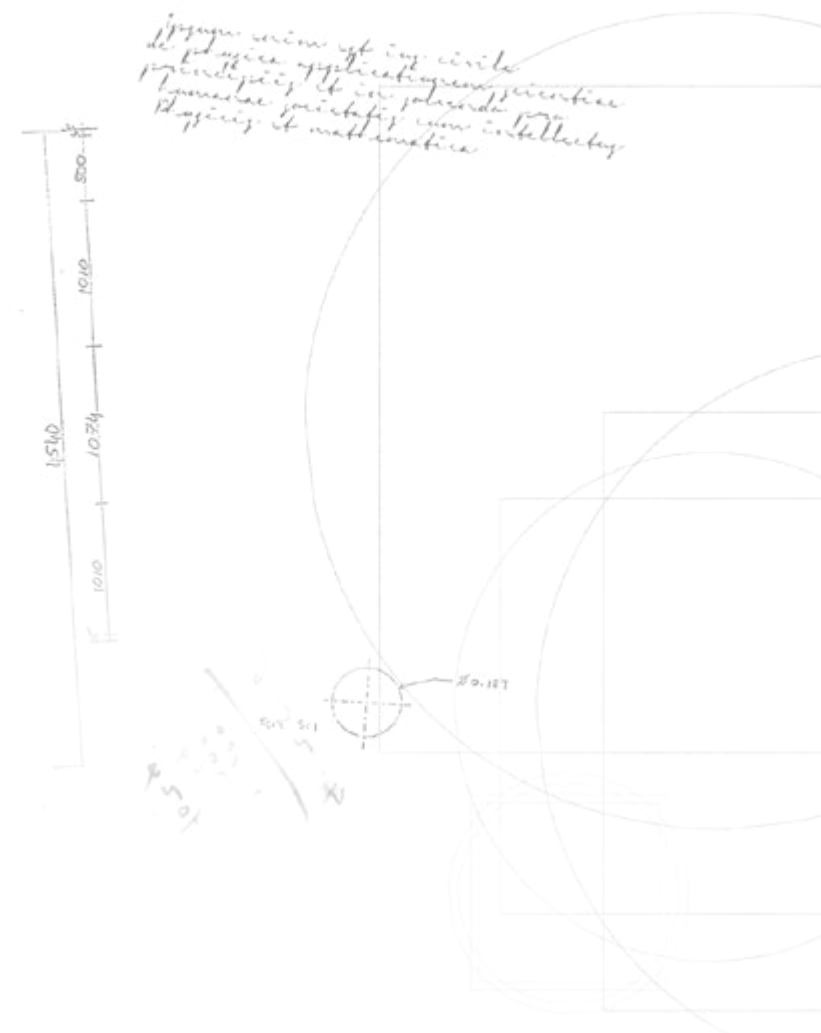

Also, the CO₂ capture process requires additional energy compared with the conventional blast furnace route, resulting in higher coke consumption and more pollution.

Overall, CCU is the most energy-intensive CO₂ reduction option for the steel industry and one of the most expensive ones.

For these reasons, and especially due to its insufficient CO₂ reduction potential, CCU does not represent a long-term option for climate-neutral steel production and can, at most, be a bridging technology for reducing CO₂ over the short term in existing conventional blast furnaces. However, there is a very high risk of stranded assets even in this case.

Example: Carbon2Chem®

A pilot plant in Duisburg, Germany, run by steel company ThyssenKrupp and companies from the chemical industry demonstrates how CCU technology can be used to capture waste gases from conventional steel production and make them usable for the chemical industry. The processes are scaled up for industrialisation from 2020 onward.

[-> Read more](#)

Example: India's first CCU facility

One of the leading steel manufacturing companies in India, Tata Steel, commissioned a carbon capture facility at their steel plant in Jamshedpur, India. It aims to extract five tonnes of CO₂ per day directly from the blast furnace gas. The captured CO₂ will be reused on site by sending it back to the gas network with an increased calorific value.

[-> Read more](#)

Carbon capture, usage and storage (CCUS) / negative emissions technologies

CCUS is a controversial issue (see also box "[CCUS in the energy system of the future](#)" on page 70) that is perceived differently by various experts, institutions and nation states. Many are aware that CCUS technology exists and has been used for years, but mainly in specific sectors such as small-scale applications in industry and subsequent use of the CO₂ in the enhanced recovery of natural gas. However, many challenges have yet to be resolved.

Currently, experts believe there are three key fields in which CCUS could play an important role:

1. Production of low-carbon hydrogen at scale
2. Deep decarbonisation in hard-to-abate industry
3. Delivering negative emissions

CCUS may be an option for the production of 'blue hydrogen' (from natural gas with CCUS). Expert assessments of the potentials are the subject of controversy. Producing hydrogen at the source of natural gas wells can potentially use existing infrastructure (e.g., pipelines) as well as storage facilities (e.g., gas wells) and can help reduce emissions over the medium term. Issues relating to costs and long-term implications when lock-ins are to be avoided are currently under debate. The production of blue hydrogen does imply CO₂ emissions and for this reason cannot be seen as a permanent option towards a climate-neutral energy system.

Many climate scenarios give CCUS a clear role in reducing emissions in sectors where alternative zero-carbon technologies are not available. Cement is one prominent example where CO₂ is emitted by deacidifying the limestone used as a raw material in cement production. In this case, CCUS is likely to be an important technology complementing other emissions reduction solutions in the construction sector (e.g., new construction materials and circular economy approach).

From a long-term perspective, CCUS can play an important role in achieving negative emissions. Many climate scenarios rely on negative emissions after 2050 – either to compensate for emissions that are extremely difficult to avoid (e.g., in agriculture) or to compensate for overshooting of the greenhouse gas emission budget before 2050. Negative emissions could be achieved by extracting CO₂ from the air with subsequent storage (direct air capture – DACCS) or from biomass burning with subsequent CO₂ capture and storage (BECCS).

In conclusion, CCUS will likely play a role on the path towards a climate-neutral economy in specific fields. However, a shift is occurring in terms of the expectations for the sectors and applications in which it will play a role. The magnitude of CCUS use and its distribution among countries is still unclear, but CCUS is likely to play a future role for sectors with unavoidable emissions, such as the cement industry.

Hydrogen

Technology overview

The expectations for the role hydrogen will play in the transition to a low carbon energy system have been quite diverse over recent decades. At the beginning of the millennium, some experts saw fuel-cell driven cars as close to commercialisation, while a few years later others coined the term ‘all-electric society’. Today, there is a growing consensus that hydrogen will play an important role in a climate-neutral economy. There are some applications for which the use of hydrogen seems almost inevitable.

The production of hydrogen is expected to grow in the coming years not only due to the global shift towards decarbonisation but also due to an increase in public hydrogen investments. According to the IEA, the announced clean hydrogen capacity is expected to be 322 million tons per year by 2050. These amounts of green and electrolytic hydrogen in 2050 would require a global electrolyser capacity of 3,600 GW, up from about 300 MW today, and roughly 14,500 TWh of electricity – which would be about 20 per cent of the world’s electricity supply by that point. According to IRENA, hydrogen has the potential to lower carbon emissions by up to 10 per cent on the road towards net zero.

Looking at these numbers, it is evident that hydrogen will play a huge role in the future energy mix, yet the exact pathways toward reaching these figures are still quite uncertain. In many areas, hydrogen is a reasonable option (see next page) but will have to compete with other emission-free technologies. As a result, businesses and regions are still hesitant to make investment decisions for the most part.

IN BRIEF

FIGURE 26
Hydrogen Energy Global Road Map 2020–2050

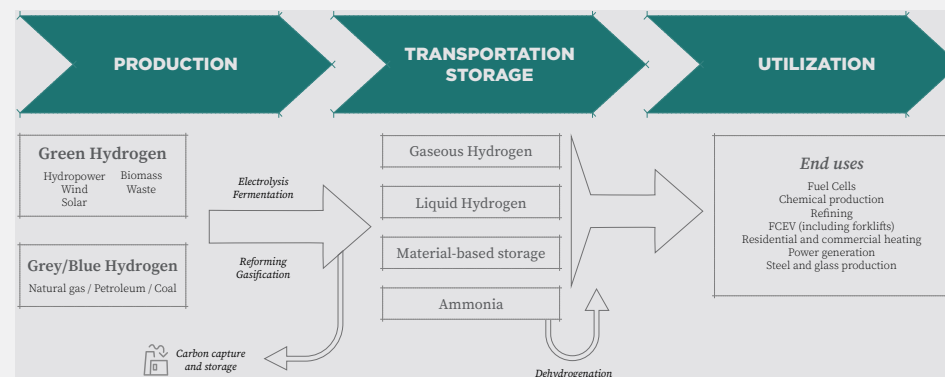

Source: Daydream 2021

Hydrogen is not a fuel, but an energy carrier

Hydrogen is often described as a fuel and, from an end user’s point of view, it will be consumed as such. But unlike natural gas or oil, hydrogen needs to be produced. This makes it more of a means of storing, transporting and re-distributing energy. Today, the largest share of hydrogen is used in the chemical industry (as a feedstock more than an energy carrier). It is mainly produced using fossil energy (coal and gas). In future, the production of hydrogen will need to be low-carbon and eventually zero-carbon.

Future application

Feedstock in the refining and chemical production industries

Most of the hydrogen produced today is used as feedstock to make other materials, primarily in the refining and chemical production industries. Due to a continued demand growth rate of 1–3 per cent per year, the challenge lies in decarbonising today's 'grey hydrogen'. About 95 per cent of current production comes from natural gas or as a byproduct.

Sustainable energy supply for energy-intensive industry

The steel industry is a major carbon emitter, as nearly 2 billion tonnes of steel produced every year generate around 7–8 per cent of global CO₂ emissions. The application of hydrogen is currently the foremost technological approach for the decarbonisation of production processes. However, the switch to hydrogen will be challenging, as it requires the development of new technologies, massive investments in new production facilities, significantly higher production of hydrogen and measures to avoid the more expensive climate-neutral steel (with an expected price increase of an additional USD 180/t being jeopardised by international competition).

Transportation technologies

Hydrogen will be an option for mobility sectors for which electrification is difficult (e.g., shipping or long-range heavy-duty vehicles). Estimates project that fuel cell lorries could account for 35 per cent of overall lorry sales or more than 40 per cent of heavy-duty lorries in 2050, with a total hydrogen demand of 675 TWh. Depending on the supporting schemes and regulatory frameworks that will be established in the coming years, hydrogen and hydrogen-derived synthetic fuels could also be used to fuel freight ships and aviation.

Other uses

Hydrogen could potentially play a role as a backup storage option for electricity generation, heat supply for buildings and several other applications. However, hopes for large-scale applications should not be too high due to the efficiency and conversion losses in hydrogen production. Direct electrification will ultimately be much more suitable and cost effective. Moreover, its competitiveness will depend on the development of alternative technologies, specific regional conditions (e.g., infrastructure and availability of renewable energy) and carbon prices.

FIGURE 27
The systemic role of green hydrogen in a zero-carbon energy system

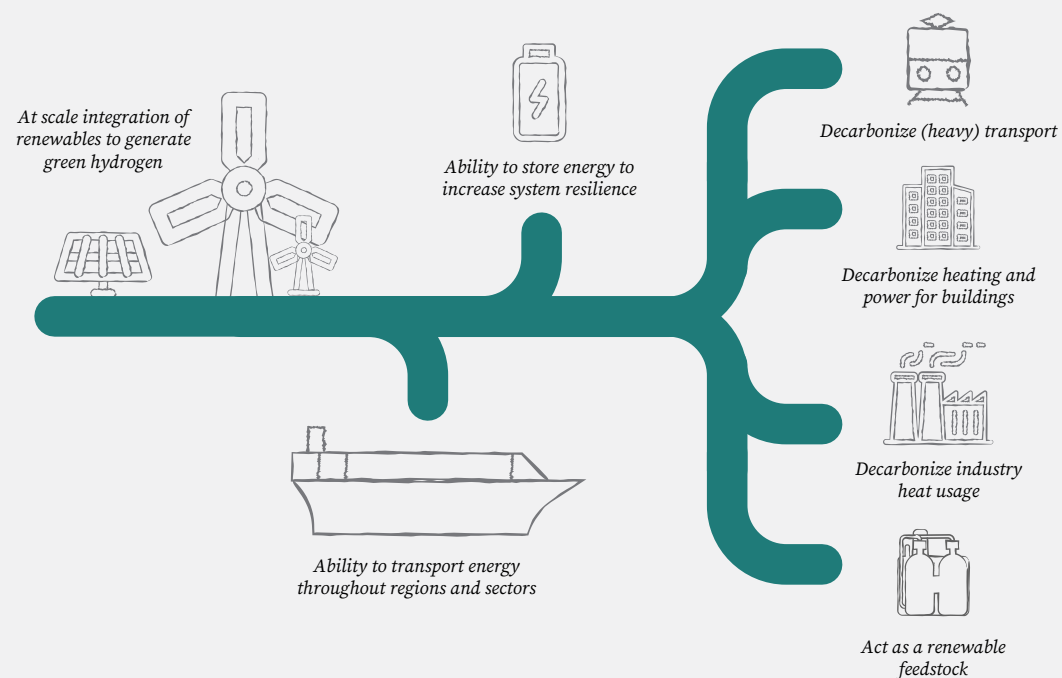

Hydrogen in coal regions

Hydrogen – an investment agenda

The transition to a climate-neutral hydrogen economy will bring massive investment needs. Figures vary depending on assumptions for future hydrogen scenarios. However, it is clear that multi-billion investments will be needed to support the development of electrolysers, hydrogen transport, distribution and storage, hydrogen refuelling stations and further supply infrastructure.

For these reasons, many regions across the globe see the transition to a hydrogen economy as an opportunity to bring sustainable economic activities and future-proof jobs to their region and are developing hydrogen strategies to reap the benefits of this transition.

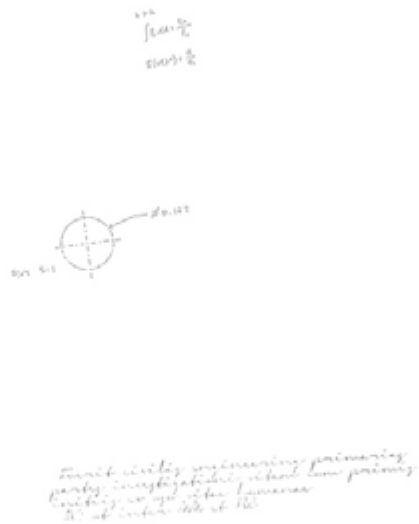

EXAMPLE

Regional hydrogen strategy in Northern Netherlands

The province of Groningen in the Northern Netherlands has developed a regional hydrogen strategy, which looks at the necessary investments into a future hydrogen economy as a great economic and job potential for the region. The strategy assesses both regional hydrogen demand and renewable energy supply options and integrates them into a consistent picture of energy import and hydrogen export with neighbouring regions and countries. This example can serve as a blueprint for other regions, which may also explore the opportunities and requirements of hydrogen irrespective of national planning.

→ **Read more:** [The Northern Netherlands Hydrogen Investment plan 2020 \(PDF\)](#)

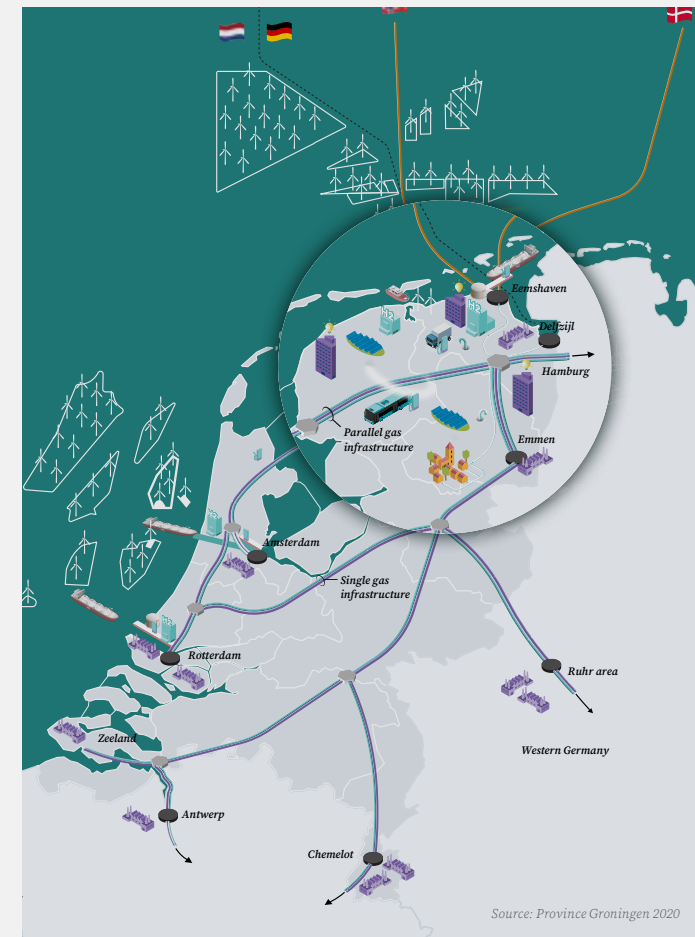

Source: Province Groningen 2020

FIGURE 28
Indicative view of the planned hydrogen ecosystem towards 2030

Strategy development

Every region planning to develop an energy transition strategy should focus on regional capacities and development objectives and should assess which role hydrogen is to play in it. Coal regions are diverse: some are densely populated urban regions, while others are rural regions often facing the challenges of shrinking population; some are heavily industrialised while others rely on agriculture or tourism. Consequently, the future role of hydrogen will vary significantly across coal regions.

Key questions are:

- What do potential future demands in the region look like (assuming a transition towards a climate-neutral economy)?
- What potential does the region have in terms of producing hydrogen?
- What are the region's infrastructure needs for transporting hydrogen? How could existing infrastructure be used for hydrogen?

The answers to these questions vary from region to region, but they are fundamental to developing a suitable hydrogen strategy, steering long-term investments in the right direction and aligning private and public actions and responsibilities.

TOOL

UN guidelines on the potential for PPPs

The use of public-private partnerships for just energy transitions

The goal of public-private partnerships (PPPs) is to exploit synergies in the joint innovative use of resources and in the application of management knowledge while attaining the goals of all parties involved to an optimal extent. The use of PPPs can offer benefits over strictly private or public ownership, especially in infrastructure and renewables development. However, a clear mandate and fair distribution of risks and benefits are key to maximise the performance of PPPs. For this reason, countries need to have in place the institutional capacity to create, manage and evaluate PPPs. The UN provides [guidelines](#) that are intended to help governing authorities examine the potential for PPPs to contribute to Just Transition development. The [World Bank's International Finance Corporation](#) supports national and regional governments in the Global South with the development of effective PPPs in various sectors and provides a comprehensive overview of good practice examples relating to PPPs.



Regional hydrogen demand and production potential

Today, hydrogen is produced and used in many regions, mainly as a feedstock for the chemical industry. The short-term challenge will be to switch the production of this feedstock hydrogen to a low-carbon energy supply.

The longer-term future demand for hydrogen will depend on several factors.

- **Overall population and population density:** the demand for hydrogen will directly depend on the number of inhabitants in the region, especially in terms of transport.
- **Technological choices and developments:** the use of hydrogen will not only depend on general technological developments (in the field of hydrogen and alternatives) but also on regional technology choices, such as whether a region invests more in overhead lines for e-lorries or extends hydrogen facilities.
- **The structure of the economy:** energy-intensive industries in particular will have a high hydrogen demand in a carbon-neutral economy.

Another key question is, how much clean hydrogen can a region produce? Producing green electricity or green hydrogen offers great economic and job potential for those regions with high renewable potential, or better, 'higher potentials': in particular, those regions that can produce more electricity than needed at low costs could potentially become suppliers of hydrogen to be used by customers in their own region or to be exported to other regions. This will be especially the case for regions with vast shares of unused and/or cheap land, as well as favourable conditions for wind or solar power.

Examples

Hydrogen production at a former coal-fired power plant site in Hamburg, Germany

A consortia of Mitsubishi Heavy Industries, Shell, Vattenfall and local energy company Wärme Hamburg are planning to build a 100 MW green hydrogen production facility at the site of the coal-fired power plant Moorburg in Hamburg, which only began operating in 2015 but ceased operations in 2020. Due to its position in the port of Hamburg, in close proximity to energy-intensive industry companies and with access to the existing gas network and electricity grid connection, the project is expected to be key for decarbonisation efforts in Hamburg and aims to become a 'green hydrogen hub' following its completion in 2025.

[→ Read more](#)

Green hydrogen to decarbonise steel production in Mo i Rana, Norway

In collaboration with steel-producing company Celsa and Mo Industry park, energy company Statkraft is planning to set up a 40 MW alkaline electrolyser to decarbonise the steelmaking process at Celsa. The project aims to begin operation by the end of 2023. Additional industrial opportunities for green hydrogen will also be exploited within the industry park.

[→ Read more](#)

REFHYNE project

The REFHYNE project, funded by the Fuel Cells and Hydrogen Joint Undertaking, aims to build and operate the world's largest PEM electrolyser at Shell's Rhineland refinery in Cologne. The 10 MW electrolyser is being built by ITM Power, and operation is scheduled to begin in 2021.

[→ Read more](#)



Handwritten notes: "Moorburg, Hamburg, Germany" and "100 MW green hydrogen production facility" with a date "2025".

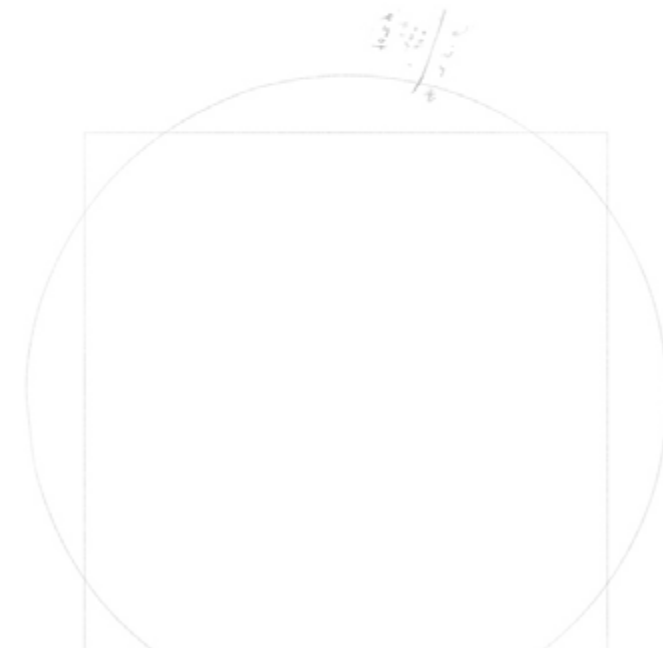

Hydrogen infrastructure

Hydrogen infrastructure needs to take into account:

- Existing infrastructure (e.g., for natural gas) that could be converted for hydrogen use.
- Geographical conditions (access to rivers, sea, etc.).
- Hydrogen needs and supply options of neighbouring regions (national and cross-border).
- Long-term time horizon and high investments for infrastructure development.
- Public-private partnerships or at least cooperation to develop a hydrogen strategy.

Any commercial use of hydrogen requires that a suitable transport infrastructure be established. There are uncertainties regarding the magnitude of future demand as well as future sources of green or blue hydrogen and their geographical distribution. The challenge is to gradually build an infrastructure that starts with robust small-scale elements and can be expanded over time.

There are different methods of hydrogen distribution that should be considered, including pipelines, lorries, ships and, to some extent, railway transportation. Pipelines can transport gaseous hydrogen and are comparably cheap as long as there is sufficient demand, which will mostly come from industrial centres with energy-intensive industries. The cost of new hydrogen distribution pipelines will require substantial investments, but the conversion of existing natural gas distribution networks will be a feasible alternative in some regions. Lorries, on the other hand, are more beneficial when demand is low and will be needed to supply hydrogen filling stations and other smaller hydrogen consumers.

Considering the current status of technological development, the establishment and repurposing of infrastructure will most likely start in industrial centres, where pilot projects have been initiated (see examples). Parts of previously grey hydrogen production based on fossil feedstocks can be converted to CO₂-free hydrogen production. Existing natural gas pipelines (if available) can be transformed into pure hydrogen pipelines transporting hydrogen to the regional centres of consumption.

As technologies improve and demand increases, national and cross border connections will be installed and shipping and import logistics will be built up. A global market for hydrogen is emerging, which increasingly determines the price of hydrogen.

FIGURE 29
Potential future steps for scaling up hydrogen infrastructure

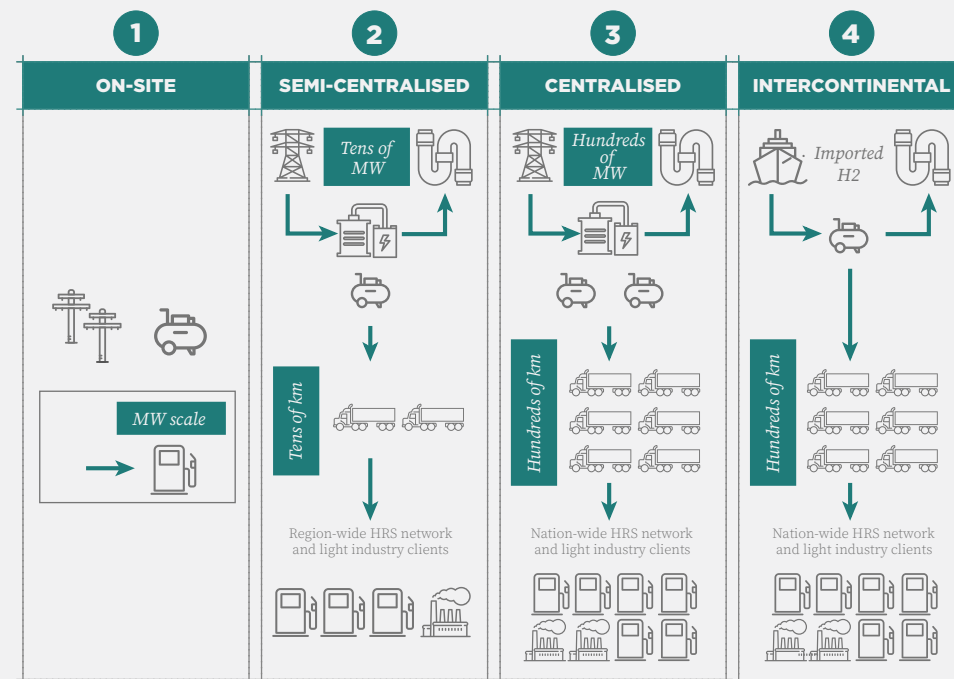

Note: The numbers 1, 2, 3 and 4 refer to the different potential future development stages in chronological order.
Based on: HINICIO (2016).

Further resources

**Svobodova, Kamila/Owen, J./Hariis, Jill (2021):
The global energy transition and place attachment
in coal mining communities: Implications
for heavily industrialized landscapes**

The paper presents an overview of the 'place attachment' factor in the context of sustainable transitions. The authors present a conceptual framework (PAHIL) for its application in heavily industrialised environments. Place attachment in the coal communities of the Czech Republic is explored as a means of supporting the development of the framework.

[-> Read more](#)

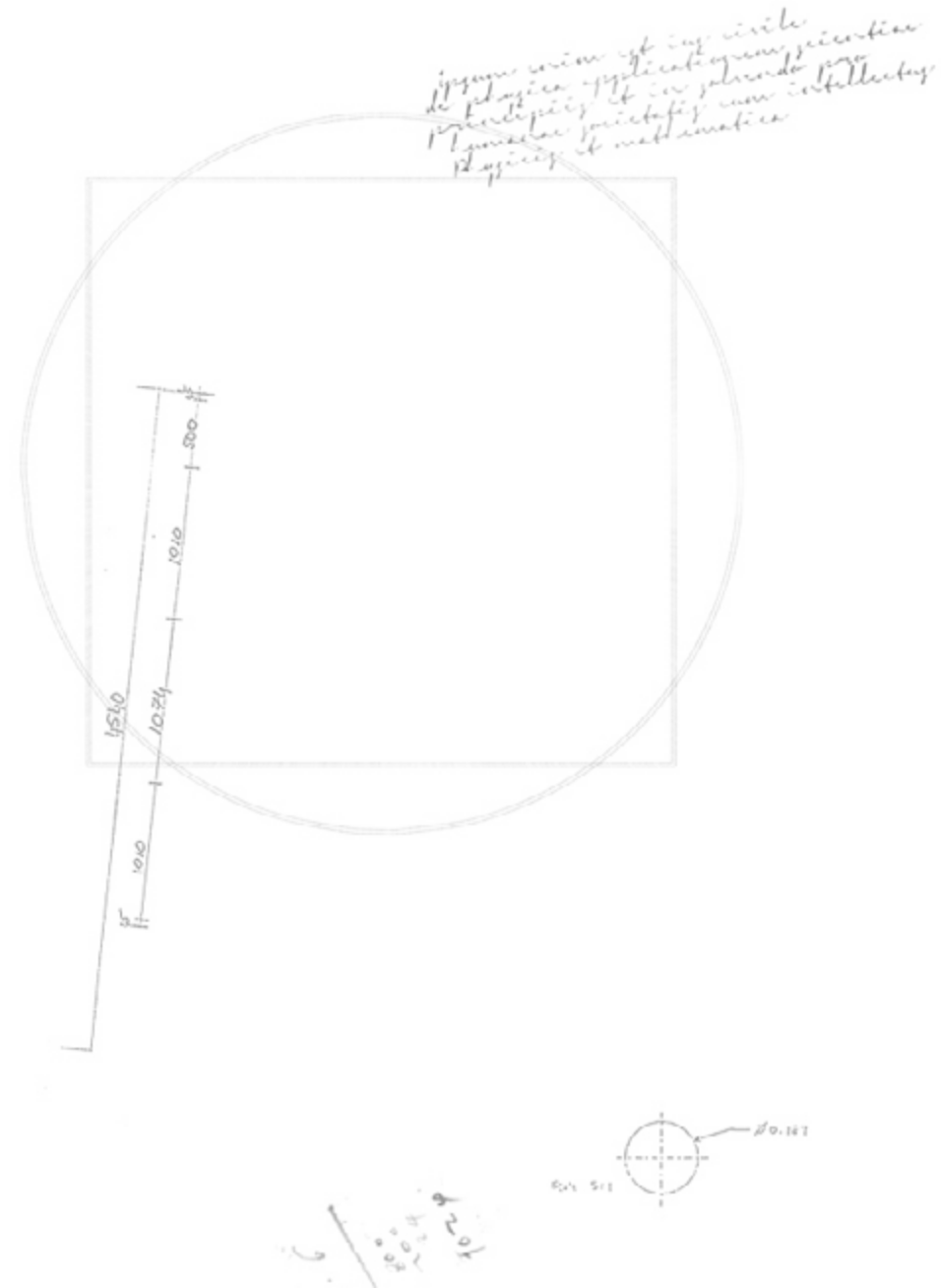

KEY MESSAGES

In the context of a Just Transition, a distinction can be made between short-term measures focusing on upskilling and redeployment of individual workers, and longer-term activities focusing on economic diversification and attracting investment to generate new jobs.

Labour market transition is a complex and often difficult process. Policy coherence and the involvement of all relevant stakeholders, including employees and those supporting them – in particular trade unions – as early as possible is key.

Foresight and planning are vital. If the timeline, focus and extent of change is known, this will aid planning and help to form coordinated and relevant responses to new developments.

Engagement with employers and trade unions via schemes such as worker transfer or on-the-job training is likely to be more effective in helping individuals to find employment, especially as compared to stand-alone training programmes.

Labour transition policies and programmes need to take into account the pronounced gender dimension of many environmental challenges and opportunities.

Moreover, measures should support vulnerable groups and communities in particular.

Introduction

The labour market transition is the biggest challenge for many coal regions

In many countries, jobs in the coal sector have been declining for years (due to mechanisation, substitution by other fuels and low economic competitiveness of mines). This process will continue in the future and even be accelerated by the need to reduce CO₂ emissions.

Mono-industrial and traditional industrial regions have a number of unique qualities that policymakers must take into consideration during transition processes. These include economic, cultural and normative circumstances.

Many of these areas depend on one type of industry and often one employer for economic prosperity. When this industry comes under threat, this will have severe economic consequences for the regions and communities. The regional culture is also often built around the industrial monopoly, with generations of families working, for example, as miners. This creates a type of 'lock-in,' where commuting to another region is difficult to contemplate as this is not the norm. These are relatively tightly-knit communities, and any plan to manage the transition of such areas must take into account the fact that this is not just an economic challenge but also a cultural and behavioural one. The new jobs that are generated by inward investment may not necessarily be occupied by those working in the former industrial monopoly.

There is also a temporal dimension to transition strategies. Various types of activities will be required depending on the pace of coal phase-out:

- **Fast transition:** if a coal region is being transitioned at a relatively fast pace, jobs are likely to disappear in the short term and affected workers and families will need immediate support, including income replacement through welfare, assistance finding alternative employment in the





© Samrat35 / Dreamstime.com

Informal employment in the coal mining sector

In some countries, especially in the Global South, a large share of workers in the coal industry are informally employed. In India for example, the number of informal workers in the coal mining sector is estimated to be three times that of formal workers. This means that about 1.75 million workers are estimated to be informally employed in the Indian coal mines. The informal workforce includes people receiving daily or seasonal income, such as loaders, levellers, carriers, coal transporters and others. Informal workers usually receive extremely low wages, have limited or no employee protection, no social security benefits and are not organised. They are also often migrant workers. In addition to the informal workforce, a large number of people and families depend on coal for subsistence livelihoods, gathering and selling coal in local markets.

As informal workers and coal gatherers and sellers often live in or are at risk of poverty, have low levels of education, no or few labour rights and are not unionised, they are extremely vulnerable – both to changes in the coal sector, such as privatisation or mine closures, and to the environmental and health risks of mining and coal use.

A Just Transition must ensure that, in addition to the interests and needs of formal workers, the interests and needs of informal workers and coal gatherers and sellers are also taken into account. In concrete terms, this means that informal workers and people who depend on coal for subsistence livelihoods

- Are recognised by local and national governments, companies and trade unions as key stakeholders in the coal industry and its transition.
- Can participate in negotiation processes and have their voices heard equally.
- Get access to compensatory measures, skills training and alternative employment opportunities.

short term, or early retirement. This is the case, for example, in many regions in the EU, e.g., in Spain, where the coal phase-out is being accelerated.

- **Slow transition:** in other communities, the phase-out may be over a much longer period, which means that the adjustment plan can be drawn-up on a longer-term basis (but also needs to be started early on). This type of planning will include activities such as attracting alternative employers to the region and ensuring that the workers in the region, and particularly the younger generation, have the necessary skills to work for these alternative employers.

Managing the impact that the transition away from coal and carbon-intensive regions will have on regional employment is therefore a key issue and one that involves a large number of actors (see "[Key actors](#)" on page 49). There are many issues to consider, including short- and medium-term measures such as reskilling and redeploying the existing workforce, supporting vulnerable groups and creating local employment opportunities as well as longer-term activities such as diversifying regional economies which aim to stimulate employment in new sectors. Where possible, efforts should also be made to ensure that working conditions and worker protection in new jobs are at least equal to those in previous jobs¹. Targeted and practical guidance to help those involved navigate the options and learn from existing good practices is extremely valuable in helping achieve successful outcomes.

The overarching aim of this section is to offer practical guidance on how to accompany the labour market transition as part of an overall Just Transition in coal and carbon-intensive regions. It focuses on two main pillars:

- Providing **short-term support for workers** affected by the labour market transition, and in particular targeted support for vulnerable groups of workers
- Providing **medium- and longer-term activities** that support employment and job creation through regional diversification

Gender perspectives on coal jobs and sustainable employment

The energy sector is traditionally a sector with strong male dominance. Currently, women hold only around one fifth of formal jobs in the energy sector globally. Significant factors include traditional gender roles as well as cultural norms regarding women's work. For example, in many European coal mining regions, where coal mining has traditionally been a very physically demanding but also very well-paid and socially secure job, the rumour persists that women working underground bring bad luck. In addition, flexible work arrangements that would enable women to combine unpaid care work (household, raising children) with a paid job are often unavailable. Other reasons that prevent women from working in the coal industry include a lack of measures for protection against sexualised violence (e.g., safe sanitary facilities), and especially in regions of the Global South, poor access to safe and affordable transport.

Since it is predominantly men who work in coal industry, debates on coal transitions often focus on the male miner. However, this overlooks the fact that coal transitions do have significant impacts on women's work. These impacts occur mainly in the secondary and tertiary job markets. [Studies on past coal transitions](#) show that when male miners lost their jobs, women increasingly started to work in paid jobs in order to compensate for the decrease in household income. On the one hand, this led to increased labour market participation and gave women more financial independence. On the other hand, these jobs were (and are) often precarious jobs, located mainly in the service sector and characterised by poor working conditions and wages as well as little social protection. Moreover, the overall workload for women often increased as their domestic responsibilities remained at the same level, while they also had to cope with new responsibilities as wage earners. In coal regions where women accounted for an above-average share of the coal workforce, such as in Eastern Germany, they were the first to be laid off as the workforce was downsized.

Given these factors, the following [measures](#) should be taken in order to foster gender justice in the field coal transition and employment:

- Compensation schemes must not only address the miners but also coal mining communities at large.
- Job training and qualification programmes are to be made available to all people in the affected region, not only former (male) coal miners.
- Steps should be taken to ensure that women (as well as marginalised groups like informal workers, indigenous people and members of lower socioeconomic classes) have access to newly emerging, well-paid jobs in the green economy sectors.
- Provide a safe workplace for women, including housing, sanitation and transport as well as effective protection against discrimination and access to maternity and parental leave benefits.
- Improve working conditions in female-dominated sectors like the service sector.
- Ensure all genders (and social groups) receive a good education.

¹ In the case of informal workers, there are no such protective measures in previous jobs, which should be taken into account for policy development (see also box on informal employment).

Skills

Anticipating and assessing skills needs

In many regions across the world, skills needs are more diverse and the concept of a job for life is no longer relevant. Megatrends such as sustainability and digitalisation can lead to skills gaps and mismatches; at the same time, these developments offer major opportunities for employment and growth (see also the section on economic transformation and diversification). In order to provide workers with the right types of skills to enable them to remain employable, some form of forecasting and anticipation function is necessary. This can be a difficult task and is usually a medium- to long-term activity, as it needs to feed into the training developed by vocational educational training (VET) providers, schools and colleges. Ideally, an anticipation and forecasting function would be developed in partnership between actors such as local or regional authorities, national governments, individual companies and social partners (employer and employee representatives).

A number of such initiatives already exist. Cedefop's Skills-OVATE: [Skills Online Vacancy Analysis Tool for Europe](#) offers detailed information on the jobs and skills that employers require in online job postings. Cedefop's [Skills Forecast](#) also provides comprehensive information on future labour market trends in Europe. It acts as an early warning mechanism to help alleviate potential labour market imbalances and support different actors in making informed decisions.

Successful examples also exist at the national and regional levels. In France, a national forecast is carried out jointly by the Prime Minister's office and the Ministry of Labour ([Prospective des](#)

[Métiers et des Qualifications](#)), while region-specific exercises are carried out by the French regional development agency. The public employment service ([Pôle Emploi](#)) also provides projections at the national, regional and sectoral levels.

It should be noted that the timespan and frequency of forecasting initiatives vary, and some flexibility is always necessary. Exercises to anticipate future skill needs can forecast in the short- (up to 2 years), medium- (2–5 years) or longer-term (5 years or more). Most forecasts cover a medium-term timespan of 2–5 years, and short-term anticipation exercises are less common, perhaps because their purpose overlaps with assessments of current skill needs. Nevertheless, the Italian Chamber of Commerce (Unioncamere) heads up the Excelsior Project ([Progetto Excelsior](#)), which provides one-year employment forecasts by sector and occupation.

Skills audits and skills matching

When coal phase-out is a medium- to long-term process, and there is more time to plan ahead, skills audits at the company level are important to assess the available skills in the workforce and to support employees in developing and acquiring missing skills.

Once a review of existing skills has been carried out, these can be mapped alongside development needs, identifying key elements of effective skill needs anticipation systems. Training can then be organised to deliver the skills required, followed by some form of validation and recognition.

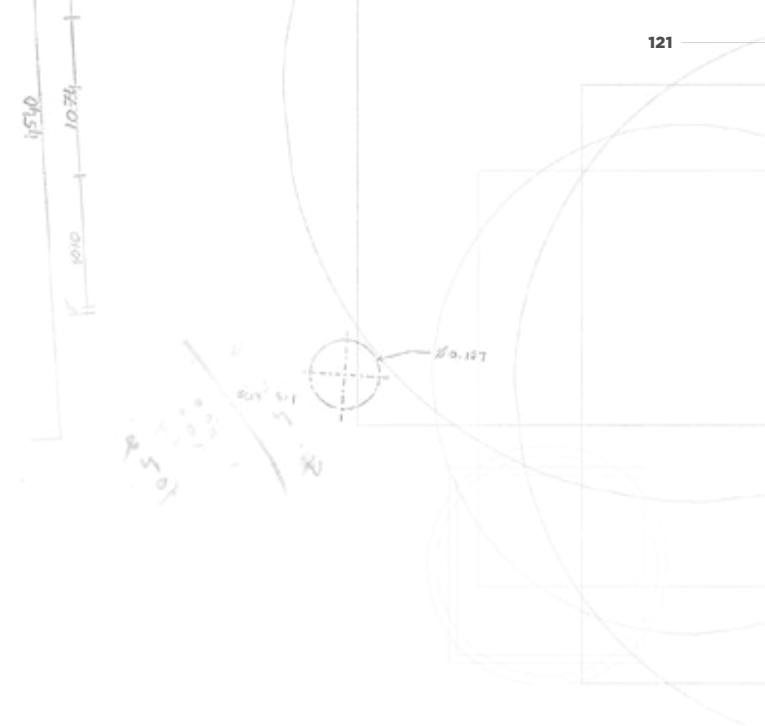

In order to provide workers with the right types of skills in the future, some form of forecasting and anticipation function is necessary

Skills development and transferability of skills to other sectors

Once the extent of existing skills is known, a process of assessing transferability to other sectors and other types of jobs can be undertaken. Where possible, working conditions and health and safety provisions should equal those in previous jobs. Mining occupations involve a high degree of physical tasks, requiring both strength and dexterity. Similar occupations may therefore be found in construction, manufacturing and some service occupations that also include physical and practical tasks, such as caretakers. Transferability of at least some skills may be also possible to jobs in the agricultural and horticultural sector. Furthermore, there are many types of skills that can be retrained and developed to be applicable to other sectors, such as those relevant to administrative, management and sales and marketing roles. Qualified technicians, craftsmen and operators of machinery and equipment are likely to find it easier to transfer to new sectors. For example, solar companies may be interested in hiring former coal miners for solar installation jobs, assembling and maintenance. In particular, electrical and mechanical skills, experience working under difficult conditions and sophisticated safety experience are highly valued in the wind and solar energy industries.

It should be noted, however, that it is by no means certain that the sectors listed above will offer jobs for life, even though they may well offer an initial opportunity to remain in the labour market. Given this fact, workers will need to recognise that they may have to change jobs more frequently than in the past. These types of jobs are likely to require more geographic mobility in terms of requiring work to be carried out in different/multiple locations.

GOOD PRACTICE

Skills development

In Wales, UK, the [Welsh Government Skills Support for Tata Steel](#) grant scheme was intended to support professional and technical skills learning relevant both to the steel industry and to wider employment markets. It includes:

- USD 5.3 million of grants for the financial year 2016–17 to support learning designed to improve professional and technical skills relevant both to the steel industry and to wider employment markets.
- A total of 5,925 employees received training supported by the Welsh government with an average of four individual trainings per employee across eight projects: improving the supply chain; developing craft skills; upskilling new talent; improving health and safety and environmental awareness; leadership and management training; and apprenticeships.
- An evaluation shows there has been a positive impact on employees and on the business in relation to Tata Steel's objectives: to transform business performance; to increase the flexibility and capacity of the workforce; to support succession planning; and to provide a safe and healthy workplace.
- Employees reported very high levels of satisfaction with the training in terms of: relevance to their job; improving motivation and confidence; improving technical skills; a positive impact on the transferability of their skills; and supporting career progression.

Another example of a skills initiative comes from North-Rhine Westphalia in Germany. [The Cooperative Training at Coal Sites – Training in Mining Regions for Young People](#) programme has been running since 2008. The programme explicitly focuses on (former) mining towns but does not aim at reskilling miners. Instead, it offers training to young people in order to give them the skills necessary to obtain a company apprenticeship or enter a company training scheme. It includes:

- A focus on encouraging inward company investment in the region in order to provide employment for young people.
- Cooperation between training providers, local employment authorities and SMEs, who together provide initial training to young people, with the goal of helping them to participate in a company training programme the next year.

Linking labour supply and demand

This is a key part of any transition strategy, and there are a number of ways to:

- Create demand for labour at the local level by attracting inward investment from new industries and new employers. This could be linked to a green energy strategy.
- Link the local labour market to wider regional opportunities. This can be difficult, given the cultural and behavioural factors linked to mono-industrial regions and a traditional reluctance to work outside the immediate community. However, this can be achieved by offering advice and support to individuals and ensuring that there is affordable and reliable public transport that connects the area with the wider region.
- Boost local job creation by encouraging and supporting entrepreneurship. Along with financing support (e.g., through start-up bank loans), advice and guidance on business start-ups is a key factor. This will help to boost business creation, leading to new job creation.

Example: The PACE programme in Scotland, United Kingdom

There are a number of examples of multi-agency or multi-actor partnerships that have achieved results in responding to large-scale industrial closures and redundancies. This includes the [Scottish Partnership Action for Continuing Employment \(PACE\) programme](#). This Scottish national strategic partnership framework for responding to redundancy situations works to ensure that local public sector agencies respond to potential and proposed redundancies as quickly and effectively as possible.

The initiative consists of a national PACE team and 18 local PACE teams across Scotland. PACE support is tailored to meet individual needs and local circumstances and may include PES (Jobcentre Plus) services, one-to-one counselling, information packs, training, seminars on skills such as CV-writing and starting up a business, and access to IT facilities.

PACE is considered to be highly successful in supporting transitions in Scotland. According to

the latest research, the [PACE Client Experience Survey 2018](#), 80 per cent of PACE customers achieved positive outcomes. For example:

- When Ageas – a major employer in Lanarkshire – had to close its call centre, it engaged with PACE at an early stage. As well as providing support to its employees, links were forged with other employers and a jobs fair was organised that brought together 40 employers

TABLE 3
Examples of skills adaptations

The table below shows examples of skills adaptations in various scenarios relating to sector, skills and region.

Sector	Skill	Region	Example
Same.	Same.	Same.	Power plant operator working in biomass power plant after plant conversion.
			Former coal miner working in an underground copper mine in the same region.
Other.	Same.	Same.	Geologist working in a research centre in the same region.
Other.	Other.	Same.	Industrial electrician retrained as wind farm technician working in a wind farm located on the site of the former coal mine.
Other.	Other.	Other.	Industrial technician retrained as wind farm technician working in wind farms located in other regions.
Same.	Other.	Same.	Geologist working as specialist tour guide with a museum after mine reclamation.

representing 2,000 job vacancies. As a result, 80 per cent of the redundant employees secured a positive outcome. PACE has produced a [YouTube video](#) overviewing this project.

- In August 2015, Scottish Power confirmed a decision to close the Longannet Power Station in Fife, affecting over 230 Scottish Power staff as well as additional contractors. PACE engaged with Scottish Power and supply chain companies to support affected employees. A range of support was provided to employees, including advice on finding work – such as on preparing CVs, cover letters and applications, interview techniques and use of LinkedIn – presentation skills, advice on claiming state benefits, business start-up advice, and support to access training, information on retirement options and pensions advice. By October 2017, out of 370 individuals, 194 were employed (192 in full-time work), five were self-employed and 23 were in education and training programmes. Taken together, this accounts for 60 per cent of the sample. A total of 77 individuals chose not to access further support, and 69 were classed as inactive due to factors such as retirement, ill health and choosing not to seek benefits. Only two people were unemployed.

Other examples of PACE support for employers are provided in its [online toolkit](#). These include success in supporting men over age 40 and cases of paper mills closing in rural or semi-urban areas.

Example: Skill Council for Green Jobs, India

The Skill Council for Green Jobs (SCGJ) is incorporated as a not-for-profit, autonomous, industry-led initiative to identify skills needs for the green business sector society and is being promoted by the Indian Ministry of New and Renewable Energy and the Confederation of Indian Industry. Its main aim is to

serve as a platform where the skilling needs of both service users and manufacturers/service providers in the green businesses sector can be identified. The council's activities consist of occupational mapping, a skills gap analysis, qualification programme and curriculum development, as well as implementation and assessment measures. Furthermore, the SCGJ intends to serve as a link between the Indian government, state governments and industry in developing and implementing skills development strategies and programmes that are both correlated

to industry needs and aligned with best international practices. It also has the potential to pave the way for putting in place national, industry-led, collaborative skills development and entrepreneur development initiatives that will help India realise its green business potential. Specifically, [SCGJ](#) aims to help in improving energy and raw materials efficiency, limiting greenhouse gas emissions, minimising waste and pollution, protecting and restoring ecosystems and supporting adaptation to the effects of climate change.

FIGURE 30
Activities of the Indian Skill Council for Green Jobs

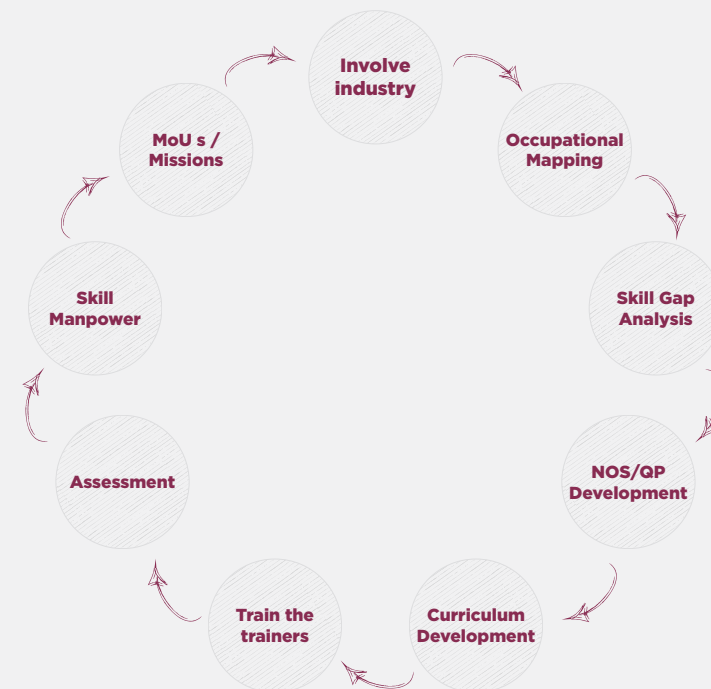

Source: SCGJ

Support for workers

Information and consultation

In a scenario in which the phasing out of coal is accelerated and there is little time for medium-term planning, short-term immediate actions to support affected individuals are necessary. Those affected will also need a lot of reassurance; they are likely to have the following key questions when confronted with restructuring:

- How will you ensure that I can find an alternative job or a bridge to retirement?
- How will my livelihood be guaranteed during the adjustment process?
- Who is going to pay?
- Why should I trust them?

It is understandable that employees want to be included, in good faith, and early on in the process of any restructuring plans likely to affect them. They also want to be given a chance to play a meaningful role in decision-making processes that concern their futures. This usually takes place through trade unions, which have the right to represent workers collectively in statutory information and consultation processes. It is best practice that employers consult with their workforce on their restructuring plans in good time and in a way that enables meaningful dialogue between the employer and employee representatives. In practice, this means that, while the overall aims of restructuring may have been decided, the decision on how restructuring should be implemented should be discussed and reached jointly between the employer and the employee representatives.

For informal workers, trade union representatives can play a role for information and consultation as well, depending on their terms of engagement. Another alternative is addressing the larger community, through a public consultation and stakeholder dialogue process. District authorities or similar actors can facilitate this along with support of local representatives and stakeholders particularly of mining and industrial areas, industry members, local civil society members, etc.

Tailored support for workers: who is being targeted?

It is important to offer support to all workers who are affected by industrial change in the region in which they work. Ideally, the move should be away from the coal sector, in the context of coal phase-out. However, in some cases, a temporary move to other coal businesses may buy some time to allow the individual to think about longer-term options and the acquisition of relevant skills and competences. Support can be offered by a range of experts and stakeholders, including trade unions, other employment experts or a mixture of actors.



Specific requirements of certain groups of workers

Certain groups may be more vulnerable than others. Those who are:

- **Unemployed on a long-term basis (12 months or more)**, for example, may find it harder to integrate into the labour market. In these cases, the following are particularly important:
 - › Skills mapping, targeted training and development, work or training placement.
 - › Practical assistance with job applications, CVs, interview techniques.
- **Young people** may not have developed adequate skills and experience to enable them to enter a new type of labour market. It is important to offer:
 - › Assistance with gaining work experience placements/internships.
 - › Training and upskilling.
- **Older workers (over the age of 50)** may be vulnerable due to health issues and perceived lower adaptability and productivity. It is important to offer:
 - › Support with training and upskilling or skills reconversion.
 - › Support in managing any health issues.
 - › Advice on early retirement or bridging period options.
- **Informal workers** are the most vulnerable group of workers as they are traditionally overlooked by skills measures and learning in general. Promising approaches are:
 - › Recognition efforts of prior learning and certification of skills.
 - › Informal apprenticeships.
 - › Dual-type apprenticeships that combine in-classroom and workplace training.
 - › Community-based training initiatives for rural economic empowerment (e.g., the ILO's TREE programme).
 - › Digital learning and training solutions.

GOOD PRACTICE



Engaging with the workforce

The workforce should be provided with as much information as possible in order to convey a broad picture of the situation. If the employer imparts high-quality information to the workforce in a timely manner, this will help to gain the trust of the workforce and its 'buy-in' to the process of restructuring. Examples of good practice in this regard include:

- Limburg, in the Netherlands, where trade unions were given an active role in committees that oversaw the transition process for the region.
- In 2018/19, trade union representatives participated with voting rights in the German Commission that developed both a timetable for coal phase-out and cornerstones of support schemes for the German coal regions.

Specific types of support

Individual skills review

All individuals affected by the transformation of their sector should be offered an individual skills review, during which they can meet with a skills assessor in order to map their particular skills. These can include both formal educational and vocational qualifications and informal skills learnt during employment, with a focus on those skills that go beyond the job they have been doing up to that point. This will enable the individual to think about the type of work that they may be able to do in future and the type of training that they would like in order to develop their skills and competences to take advantage of new opportunities.

Once an individual's skills are reviewed, they can be matched to available vacancies and training opportunities.

Career counselling

Individuals should be offered career advice and counselling, building on their skills review. This will help them to explore current options and future goals. Overall, it should be noted that those involved in the coal industry are often reluctant to take other types of employment and may see work in the service and trade sectors as humiliating. It is therefore important to focus on how existing competences can be transferred to other sectors and how training can help individuals to gain new and valuable competences.

Devising an upskilling pathway for individuals is a good way of focusing on where an individual is at present and where they want to be. There are many [examples of good practice](#) showcasing possible ways to implement upskilling pathways.

TABLE 4

Skills review: aims and actions

Aim	Action	Suitable type of worker	Time scale
Move to an alternative role within the company.	Support workers who have appropriate skills and/or are willing to retrain to take on alternative roles.	All with relevant skills and disposition.	Short/medium-term.
Move to alternative coal-based sites in the company.	Practical support to transfer to another site.	Those who may find it hard to find work in other roles or sectors.	Short-term.
Move to an alternative local job.	Regional worker transfer programmes. On-the-job training.	All with relevant skills and ability to move to an alternative local job.	Long-term.
Move to another sector.	Targeted training.	Workers likely to succeed in other sectors, particularly young people and those with post-secondary education.	Long-term.
Move to another sector in another region.	Targeted training. Practical and financial support for relocation.	Those likely to succeed in other sectors and who are willing and able to relocate geographically.	Long-term.
Voluntary redundancy.	Support package, including reconversion plan.	All.	Short-term.
Retirement.	Early retirement. Providing a bridge to pension.	Older workers.	Short-term.

Source: ILO 2018

Training opportunities

Once a skills audit and counselling have taken place, an individual will be better placed to review the training opportunities that are on offer.

Guidance and support from a careers advisor should include communicating the relevant training opportunities to individuals and providing practical assistance on how to apply for training courses.

Evidence suggests that stand-alone training programmes have limited success. For example, [research](#) suggests that only 30 per cent of such programmes achieve some degree of effectiveness, and their success is often limited due to factors such as structural unemployment in the region, a lack of engagement with potential employers, a lack of a holistic approach to supporting workers and a lack of monitoring outcomes.

Where possible, worker transition programmes should therefore focus on placing workers in jobs, or jobs coupled with retraining, rather than providing stand-alone retraining programmes.

Other practical assistance

Other types of practical assistance include the following:

- Help with how to put together a job application
- Assistance with updating and producing a CV, including how to use computers to do this
- Where applicable, financial advice. Individuals faced with losing their jobs and needing to find alternative employment are likely to have financial concerns. Advice on how to manage personal and family finances, including bridging transition periods between work, can help to ease anxiety.

EXAMPLE

Labour market measures in Saarland and Ruhr regions

The Saarland and Ruhr regions in Germany provide a good practice [case study](#) of a large and gradual restructuring and coal phase-out process that began in the 1950s. The transition has encompassed a wide range of activities, including attracting other industries to the region, such as automotive and tourism, and making significant investments in R&D by establishing technology parks, supporting technology transfer and offering targeted support to SMEs.

The German energy and mineworkers' union IG BCE was an important actor in facilitating and negotiating the coal phase-out. As a result, a socially accepted phasing-out of subsidised coal production in Germany took place gradually and was completed in 2018. This was governed by a collective wage agreement on socially acceptable personnel measures. Structural regional policy and the European Structural Funds and the Cohesion Fund were also crucial to the process.

Coal mining company Ruhrkohle AG was established in 1969. From 1969 to 2015, employee numbers shrank from 180,000 to 9,500. A social compensation plan was set up to support workers in transitioning to new jobs. This included the following elements:

- Early retirement, with the precise nature of the package depending on the age of the workers and the type of job that they had been doing (e.g., underground or surface mining)
- Qualification or retraining initiatives (around 26,500 individuals pursued this option)
- On-the-job qualification initiatives
- Direct redeployment
- Temporary placements
- In-house redeployment
- Redundancy payments
- Around 3,000 workers in total moved to other sectors (for example, around 100 former miners are now working at the Dortmund Airport).
- Coal heritage projects: the Zollverein industrial complex in Essen, formerly the largest colliery in the world, was converted into a museum and a UNESCO World Heritage Site, which now receives 250,000 visitors a year.

-> **Further reading:** [Lessons from Germany's hard coal mining phase-out: policies and transition from 1950 to 2018.](#)

Economic diversification and transformation

Economic transformation: why diversification matters

As indicated in the beginning of this section, an economic transformation is the second important pillar of a labour market transition. In the past, many coal mining areas that experienced a significant decline in coal mining adopted a strategy of attracting large industrial players to the region. This strategy helped to create jobs in new industrial sectors with the advantage that the required skill profile is quite similar to those of the former miners. In this way, a number of the Western European coal mining regions (e.g., in the [Ruhr Area in Germany](#) or [Limburg in Belgium](#)) were successful in attracting car manufacturing companies in the 1960s and 70s. This helped to initially compensate for job and income losses in the region. In the meantime, however, many car companies have now left those regions – or are now facing challenges themselves due to the transition from combustion engines to e-mobility. As a result, even coal mining regions that closed their last mine decades ago are today in their second or third phase of structural change – and are now adapting to megatrends such as globalisation and digitalisation.

Given this, it is important to remember that transitions are not one-time events – they happen repeatedly and are sometimes visible and prominently discussed, but are also hidden and less apparent in other cases. Even when coal mining regions have fully transitioned away from coal and have successfully established new economic pillars, they will have to further adapt to new framework conditions and respond to new



challenges in future. For this reason, it will be crucial for regions to promote job opportunities in various fields. Minimising dependency on a small number of large industries can make regions less sensitive to economic fluctuations and can foster innovation in regional networks and clusters. The future is not predictable, and regions will have to be prepared to continuously respond to new challenges. However, there are trends that are foreseeable – at least to some degree (such as digitalisation). Coal regions should use these trends to ensure that the inevitable transition away from coal is a catalyst for innovation processes in the region. Activities to diversify the economic base should plan for both short- and long-term benefits for the region. Furthermore, supporting education for all people as well as building up regional higher education and research capacities in coal regions have long-term positive effects, such as creating jobs for the children of today's miners. Regions should also consider how local smart specialisation and economic diversification processes and actions can support mitigation targets. This is also in regions' self-interest; attracting companies and building infrastructure that rely on a high-carbon business model may become stranded assets in the future.

Ultimately, from the workers' perspectives, the crucial aspect is not only the number of jobs and their regional distribution – but also the quality of the work. In the past, many jobs in the coal sector – and especially mining – came with pros and cons, such as high health risks but good pay. It is important to provide a framework that ensures new green jobs can also be considered good jobs with respect to health, pay as well as labour and social standards.

EXAMPLE

Zukunftsagentur Rheinisches Revier

A regional economic development agency in Germany's largest lignite mining area as a governance mechanism to diversify the local economy

Since 2014, regional development agency 'Zukunftsagentur Rheinisches Revier' (Future Agency for the Rhenish Region, ZRR) emerged to become the main regional coordination mechanism in the Rhenish coal region in North Rhine-Westphalia, Germany. The agency's shareholders are local municipalities, regional business associations and the trade union for the industrial sectors of mining, the chemical industry and energy (IG BCE). This setup has helped to reduce competition among the main sectors and forms the basis of a future-oriented concept for proactive structural change. The main responsibilities of the ZRR are:

- Identifying regional development potentials.
- Coordinating a regional strategy and vision development process.
- Promoting and supporting stakeholder exchange processes.
- Pre-selecting projects under public funding programmes.
- Technical assistance for project development (funding consulting, scouting, etc.).

By fulfilling these various roles, the ZRR became a main coordinating player in the region, gaining and pooling a wealth of expert knowledge regarding the region and its development potential while at the same time aiming to steer the region's development process in a direction that is in line with national and international climate targets. In this sense, an agency like the ZRR that pools different roles within a single organisation can be a powerful tool to link strategy with economic diversification and economic development measures in a complex transition process.

→ [Read more](#)

Governance models to manage economic development

Multi-actor partnerships have the potential to play a significant role in the labour market transition, which is a key component of the overall regional structural change process. In this section we focus on examples and initiatives that are already underway in the field of labour market transitions. For a general overview of the actors, stakeholder engagement models and answers to questions as to why stakeholder engagement processes are important, please see "[Designing effective governance models](#)" on page 40.

For policymakers, the main challenge is to transfer the above-mentioned goals of economic diversification into a strategy and political framework that not only pursues growth and jobs but also ensures long-term sustainability. Explicit transition governance agencies (such as the ZRR, see below) or so-called intermediaries can help to structure and coordinate complex processes of economic diversification across government bodies, diverging interests and over a longer period of time.

Tool

SIA Toolbox: development of sustainable industrial areas

'Sustainable industrial areas' (SIA) is a concept that aims to balance economic, ecological and social aspects in industrial areas and especially in industrial parks, which can be found in many regions across the globe. Given that sustainable industrial areas require particular management structures that organise and plan measures related to resource and energy efficiency, environmental protection and social compatibility, the GIZ developed a toolbox that provides guidance on performing a preliminary analysis as well as planning and operating a sustainable industrial area. The toolbox offers a wide variety of measures and tools and aims to improve the environmental performance of both individual companies and industrial areas as a whole.

→ [Read more](#)

FIGURE 31
The three major phases and thematic subtopics of the SIA Toolbox

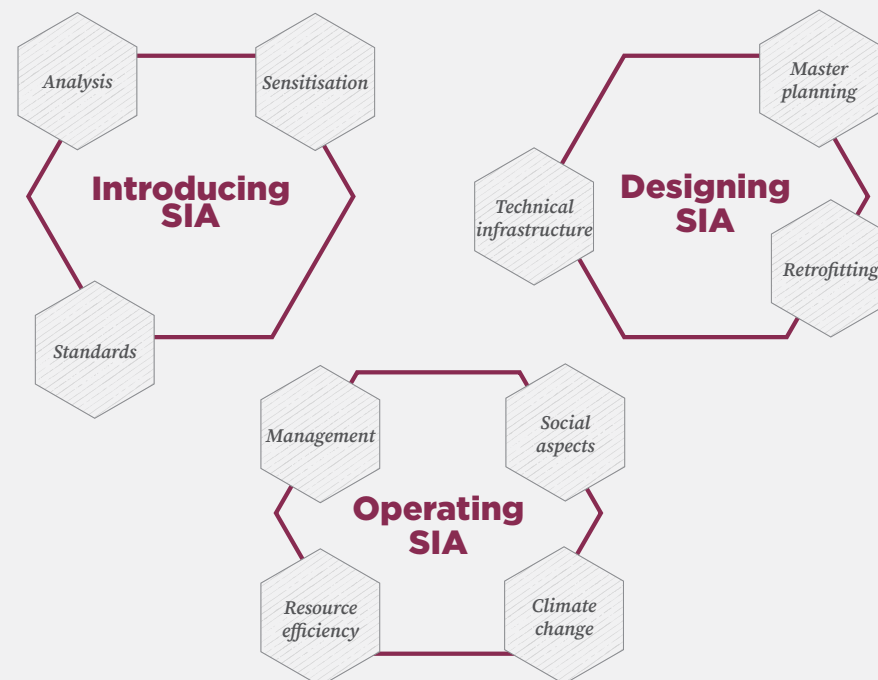

Potential sectors with (further) development potential

The following sections provide an overview of areas and sectors that could be promising for coal regions in terms of economic impact and job creation potential, with examples and tools that can help to identify development potential and manage change processes at the regional level.

Entrepreneurship and small businesses

One approach to diversifying the economic base is fostering entrepreneurship, small businesses and start-ups in coal regions. There are many positive examples of ongoing activities of this nature; however, this strategy also poses significant challenges. One of these is culture: most industrial workers are used to working for large companies, with clear rules and responsibilities and social benefits supported by strong labour unions. Very few find it easy or even desirable to become an entrepreneur and thereby lose these means of support. For trade unions, the main challenge is ensuring strong membership that enables unions to fight for good terms and conditions, including pay that corresponds to the relatively high levels of pay for miners.

Energy and energy efficiency

Clean energy technologies offer great economic and job opportunities for both active and former coal mining regions. Nevertheless, when carbon- and resource-intensive industries are phased out, the transition to a green economy will inevitably result in job losses in some sectors. [According to ILO](#), the coal industry is one of the industries set to experience the most significant decline in job demand due to the transition to sustainability in the energy sector. Mining of coal,

TOOL



Supporting entrepreneurs

[Climate-KIC](#) identifies, supports and invests in entrepreneurs through every stage of innovation, helping them move from initial concepts, through to testing and demonstration, and all the way to achieving commercial scale. This approach targets young entrepreneurs, individual start-ups and local initiatives who themselves support new entrepreneurs (e.g., so-called ‘impact hubs’). Another example are clusters which aim to improve performance and increase competitiveness through transnational and international cooperation. The European Cluster Collaboration Platform provides a mapping tool to locate existing clusters which mainly targets EU regions but also shows clusters outside of Europe.

→ [Read more](#)

lignite and peat extraction, as well as production of electricity using coal is set to see a combined loss of 1.5 million jobs by 2030. However, numerous publications and projections suggest that these numbers will be more than offset by new job opportunities. The International Energy Agency's (IEA) latest estimates project a net gain in employment of 25 million jobs by 2030 in clean energy and related sectors. According to IRENA's latest estimates, around 12 million jobs have already been created in the renewable energy sector today. These numbers could continue to increase as the transition to renewable energy accelerates: under IRENA's climate neutral scenario (1.5° scenario), an additional 20 million jobs could be created in the renewable energy sector by 2050 compared to business-as-usual development (see figure 32).

Supporting renewables and energy efficiency therefore not only promotes the transition to a climate neutral energy system but can also provide extensive economic opportunities for coal regions. As the specific potential for renewable energy differs from country to country and region to region, it is crucial to carefully analyse the extent to which the renewable energy sector can serve as an alternative development pathway in a region. In rural regions, wind, solar and bioenergy may offer great potential for both energy supply and job creation (see "Renewable energy technologies" on page 69). In more urban areas, specifically in northern climates, improving energy efficiency is another lever to create new jobs at the regional level. The modernisation of buildings is a prominent example where a high share of the value added goes to (mainly local) construction companies.

Country example: employment potential of renewables in Korea

A recent Climate Analytics publication finds that South Korea can create more than 62,000 more jobs per year on average in the first half of this decade and more than 92,000 jobs per year in the second half of the decade when the country invests into a strict coal-to-renewable scenario. In this scenario, the estimated average job potential from 2020 to 2030 exceeds that of the current policy scenario by nearly 2.8 times when all job types and technologies are considered. Job losses due to coal phase-out would be

outweighed by newly created jobs in renewable energy and related storage technologies in all provinces of South Korea, and even in coal dependent provinces, the construction and installation, operation and maintenance of solar PV and wind, as well as related storage, could provide a net benefit that outweighs job losses related to fossil fuels. In conclusion, this report finds that the potential for job creation in the operation and maintenance of newly installed renewable and storage installations could more than compensate for the job losses caused by the closure of all coal power plants in South Korea by 2029.

FIGURE 32
Potential for employment in renewable energy by technology (million jobs)

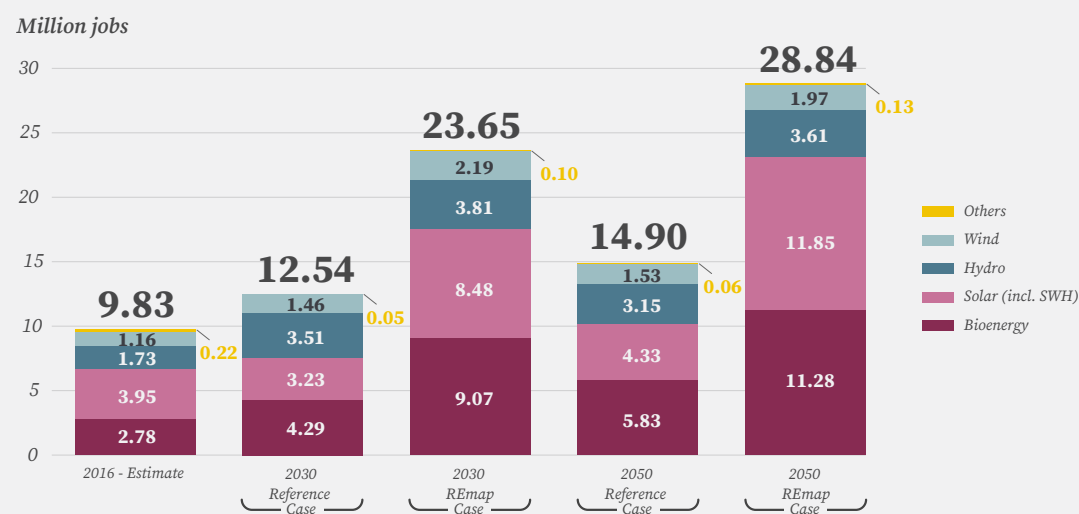

Country example: employment and energy transition in Germany

At the national level, the energy transition in Germany has led to a positive effect on employment, with new employment in [the renewables sector outnumbering job losses in conventional energy](#). The installation of renewable energy systems such as wind and solar also offer economic potential for coal regions. A [study by research institute IÖW](#) shows that in the Lusatian region, approximately 3,900 jobs in the mining industry could be fully substituted by the renewable energy sector at state level; 800 of these new jobs would be created directly in the municipalities where the coal mines are located. Similar projections have been made for the Rhenish coal mining area, where the 4,500 coal jobs could be replaced with jobs in the renewable sector, with 800 directly in the municipalities that are home to the coal mines and power plants.

Digitalisation

The need for climate mitigation is not the only driver for industrial transformation in coal regions. Rapid digitalisation and the spread of new technologies, such as the Internet of things, robotics and artificial intelligence present a challenge to the business models of many companies (putting jobs at stake) but also offer a broad range of opportunities for economic development.

While the main challenges of digitalisation for industry are related to the massive growth of digital tools that include connected objects, communication systems, data centres and associated energy consumption, research estimates that a lack of skills will create a bottleneck in the medium- to long-term process of digitalisation.

Could the energy transition be a window of opportunity for gender justice?

Globally, women hold only around [one fifth of jobs in the energy sector](#) as a whole. The picture is somewhat more positive in the renewable energy sector, although still far from equal. Here, women hold around one third of jobs globally. India, for example, has a [high proportion of female graduates in engineering](#), and its renewable energy sector tends to attract a comparatively high share of women. The transition to clean energies therefore has the potential to not only mitigate the climate catastrophe but also to advance gender equality. Nevertheless, the energy transition will not automatically increase gender equality. Among other things, this requires measures to provide a safe workplace for women, including housing, sanitation and transport, as well as effective protection against discrimination and access to maternity and parental leave benefits.

Good practices

Creating micro-business opportunities for women and enhancing the local energy transition – [the Wonder Women Eastern Indonesia Program](#)

Although Indonesia's economic development has improved in recent years, many communities in remote areas of the country still lack access to energy for daily cooking and lighting. In response, an initiative by [Kopernik](#) called the 'Wonder Women Eastern Indonesia' was created to expand energy access and simultaneously train women to become micro-entrepreneurs in Eastern Indonesia. Kopernik identifies and purchases affordable and clean energy technologies (biomass stoves, solar lights and water filters) and recruits and trains women to sell these technologies in their communities. Over the past four years, the programme has reduced energy poverty in Eastern Indonesia by increasing access to clean energy resources and helped women to gain new business skills, e.g relating to sales channels for their products, the market's needs and quality and government standards.

Gender mainstreaming through solar technology – a project by Indian social service centre [Seva Kendra](#)

The consequences of climate change pose a threat to the livelihood of many people, particularly in remote rural areas where people are dependent on natural resources for their livelihoods. The organisation Seva Kendra Calcutta initiated a project with various activities that are designed to mitigate and adapt to climate change especially for the rural people of West Bengal. It includes building solar technology capacity and establishing livelihood opportunities for rural tribal women. As part of the project, the organisation built 20 solar workshops in remote villages as practice centres. The women come to these centres to receive training in assembling solar lanterns. These technologies enable the women to earn a living and help them sustain themselves. The project also includes a community-wide discussion around women's empowerment and gender awareness as a part of awareness building on equal participation in work.

Skills gaps and mismatches are a growing issue in the area of digital and high-tech key enabling technologies. Enterprises, especially SMEs, are reporting difficulties in finding employees with these skills. Skills needs must be better anticipated in order to manage change, nurture new types of work and strengthen social cohesion. To face this challenge, it is crucial to support the upskilling of the workforce, enabling them to move into new and higher-skilled roles (e.g., via digital learning platforms such as [eSkill India](#)). Companies, governments and regions should therefore implement skills strategies according to their contextual needs and circumstances.

For coal regions in transition, digitalisation therefore presents both a challenge and an opportunity and is an issue that goes beyond the reskilling needs of workers currently employed in coal and carbon-intensive sectors ([however, there could be some opportunities, too](#)). Developing a sound, future-proof skills base in all sectors is a key element for any economic diversification and transformation strategy in coal regions.

Circular economy

The technological options in the energy and energy-intensive industries highlighted in this toolbox are providing initial guidance regarding the challenges and opportunities on the pathway towards a climate-neutral economy. Even though the application of new technologies in the value chain is crucial, those technologies are only one element in the transition. In a climate-neutral future, economies need to transform into [circular economies](#) that keep resources in the production cycle as much as possible. For businesses, reducing raw material consumption and increasing material efficiency and recirculation (e.g., in the construction sector) is expected to have a significant effect on reductions in emissions. Furthermore,

because manufacturing companies spend about 40 per cent on materials, closed-loop models can also increase individual companies' profitability while shielding them from resource price fluctuations.

At a societal level, applying circular economy principles has the potential to increase the GDP, create new jobs and help reduce environmental harm. For example, a [joint study](#) by the Indonesian government, UNDP and the embassy of Denmark projects an economy-wide rise in the GDP of up to USD 45 billion in 2030 by adopting circular economy principles, which is around 2 per cent of the overall projected GDP. The study also finds that up to 4.4 million jobs could be created under this circular economy scenario.

At the regional level, authorities can include circular economy considerations (e.g., in public procurement) by including sustainability criteria related to maintenance, recycling and sustainable sourcing of raw materials. More generally, decision-makers should integrate their commitments to a circular economy into regional or local strategies setting out priorities and measures. Creating a dedicated entity can also help to support circular economy projects, especially in the early phases of the transition.

**Circular
economy
principles has
the potential
to increase the
GDP, create
new jobs and
help reduce
environmental
harm**

Further resources

OECD (2019): Regions in Industrial Transition

Coal regions are obviously not the only regions facing challenges in structural development. The OECD Report 'Regions in Industrial Transition' explores challenges and provides recommendations on how industrial regions can support innovation, diversify and transform their economy and help workers and companies to develop required skills. The report also contains overviews of the most relevant policy issues and possible policy responses for each topic as well as global examples of good practice, many of which are from coal regions.

[-> Read more](#)

Policy Link (2015): Leveraging Anchor Institutions for Economic Inclusion

This concise briefing provides a policy perspective overview of why anchor institutions can be powerful partners in developing and implementing equitable regional economic development and sustainability strategies. Regional authorities are advised to engage with anchor organisations, use data to make the business case for anchors to support economic inclusion strategies, define responsibilities and set goals.

[-> Read more](#)

Lochner et al. (2017): Renewable energy and local development: Seven lessons from the mining industry

Because South Africa has long been dependent on fossil fuels for energy generation, it is now investing in renewable energy. As a result, renewable energy companies are often obliged or voluntarily want to engage with local communities in order to contribute to socio-economic development. The paper discusses the seven lessons learned from the mining industry that could benefit the renewable energy sector. It offers a detailed discussion of the different aspects of how renewable energy projects can support and shape local development.

[-> Read more](#)

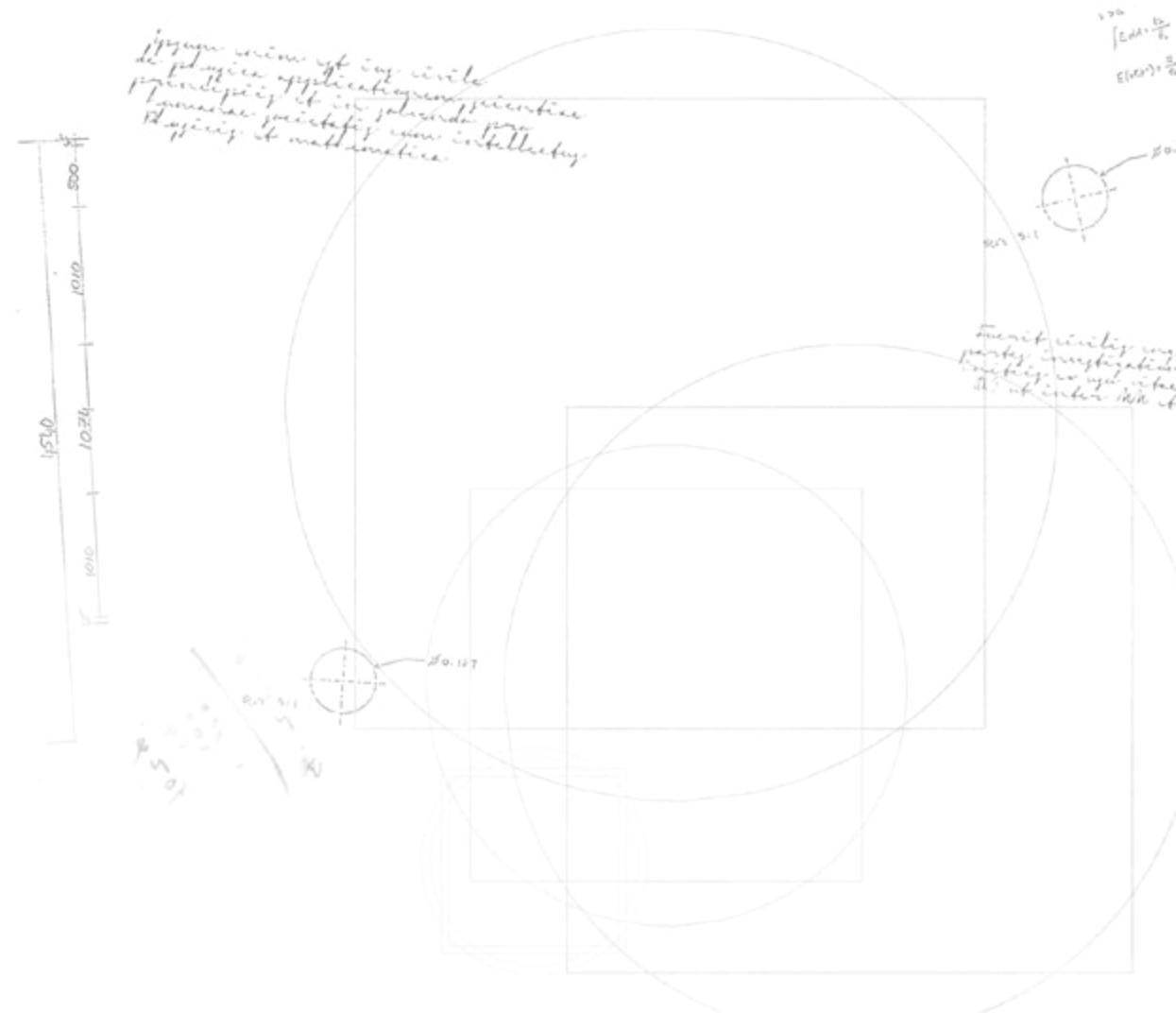

*ipsum enim est in civitate
de physica applicationem, peritiam
principis et in solvendo pro
luminata scientia, non intellectus
Physicis et mathematicis*

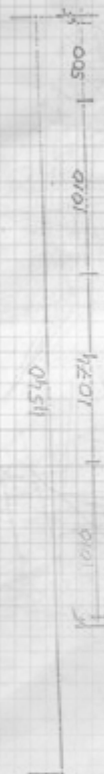

Just Transition Toolbox

for coal regions



www.wupperinst.org